

SPECIFICATION	CONNECTION	BIPOLAR
AMPS/PHASE		4.20
RESISTANCE/PHASE(Ohms)@25°C		0.90±10%
INDUCTANCE/PHASE(mH)@1KHz		3.80±20%
HOLDING TORQUE(Nm)[lb-in]		3.00[26.55]
STEP ANGLE(°)		1.80
STEP ACCURACY(NON-ACCUM)		±5.00%
ROTOR INERTIA(g-cm²)		800.00
WEIGHT(Kg)[lb]		1.75[3.86]
TEMPERATURE RISE:MAX.80°C (MOTOR STANDSTILL;FOR 2PHASE ENERGIZED)		
AMBIENT TEMPERATURE -10°C~50°C[14°F~122°F]		
INSULATION RESISTANCE 100 Mohm (UNDER NORMAL TEMPERATURE AND HUMIDITY)		
INSULATION CLASS B 130°C[266°F]		
DIELECTRIC STRENGTH 500VAC FOR 1MIN.(BETWEEN THE MOTOR COILS AND THE MOTOR CASE)		
AMBIENT HUMIDITY MAX.85%(NO CONDENSATION)		

WARNING:IN ADDITION TO THE PORT OF POWER SUPPLY AND MOTOR, THE VOLTAGE OF REST PORT MUST BE IN THE RANGE OF -0.3V~5.3V,OTHERWISE IT WILL PERMANENTLY DAMAGE THE CONTROLLER.

PLEASE REFER TO THE DRIVER MANUAL FOR ADDITIONAL INFORMATION.

TYPICAL APPLICATION

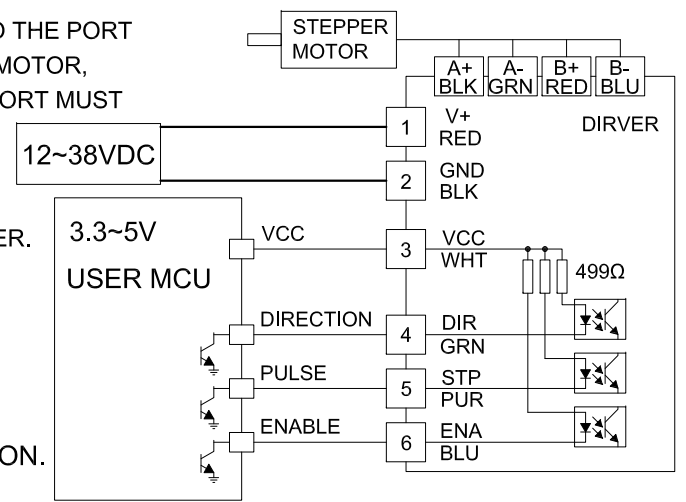

	APVD		7.18.2019
	CHKD		
1:1.5	DRN		
SCALE	SIGNATURE		DATE

INTEGRATED STEPPER MOTOR
ISD08-30