

SPECIFICATION	CONNECTION	VALUE
GEAR RATIO		50
EFFICIENCY		94.00%
BACKLASH@NO-LOAD(arcmin)		<=20
MAX.PERMISSIBLE TORQUE(Nm)[lb-in]		3.00[26.55]
MOMENT PERMISSIBLE TORQUE(Nm)[lb-in]		6.00[53.10]
SHAFT MAXIMUM AXIAL LOAD(N)		100
SHAFT MAXIMUM RADIAL LOAD(N)		300
GEARBOX MATCHING MOTOR'S INPUT SHAFT LENGTH (mm)		9.5±0.5
RATED INPUT SPEED(RPM)		1000
MAX. INPUT SPEED(RPM)		2000
NOISE(dB)		<=55
WATERPROOF RATING		IP54
LIFE(h)		20000
WORKING TEMPERATURE		-20°C~150°C[-4°F~302°F]

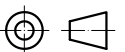
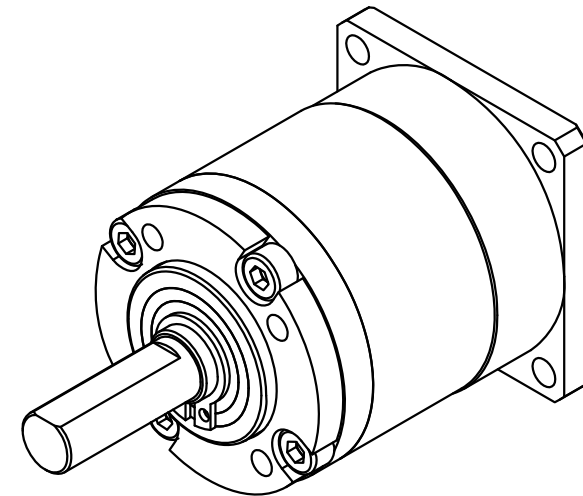

	APVD	1.19.2023
	CHKD	
1:1	DRN	
SCALE	SIGNATURE	DATE

**PLANETARY GEARBOX**

**TQEGS11-G50**