

# User Manual

For



**V70 Series High Performance Vector Control Mini VFD**



Thank you for choosing V70 series multi-function and high-performance VFD.

Faulty operation of VFD during installation, wiring and operation may cause an accident, please read the Instruction Manual carefully before using so as to master correct using method, thus avoiding personal injury and property loss due to improper operation. After reading, please keep the Instruction Manual well for future maintenance, protection and application in other situations.

For your safety, please ask professional electrical engineering personnel to install and debug the VFD and adjust the parameters.

Signs like  **DANGER** and  **WARNING** in the Manual remind you of precautions when carrying, installing, operating and checking the VFD, please strictly follow the labeled warnings to realize the safety in use.

Refer to the Manual in case of any doubts; for the problems unsolved, please contact the Company directly or our distributors, we will assign professionals to serve you sincerely.

Safety level in the Manual refers to "danger" and "warning" with the signs respectively as below:



**DANGER:** Casualties may be caused if failing to use as required.



**WARNING:** Personal injury or damage to the VFD or mechanical system may be caused if failing to use as required.

Make sure the contents with safety signs are observed. For different situations, "Warning" may also cause serious results, so it is necessary to abide by the precautions in Instruction Manual.

---



**DANGER**

- Turn the power off before wiring.
  - After cutting off AC power, high voltage still exists in the VFD before the charging indicator goes out, so it is dangerous to touch internal circuit and components.
  - Don't check the components and signal on circuit board during operation.
  - Don't dismantle or change the internal connection, wiring or components of VFD at will.
  - Don't control buttons with wet hands to avoid electric shock.
  - Earthing terminal of the VFD shall be grounded properly.
  - It is prohibited to change and replace the control panel and components at will so as to prevent electric shock, explosion and other dangers.
-



- Since semiconductor parts inside the VFD are easily damaged by high voltage, it is prohibited to perform voltage withstand test to them.
  - It is prohibited to connect the output terminal U.V.W of VFD to AC power.
  - Don't touch the VFD and brake resistor when the power is turned on or disconnected before long in high temperature, so as to avoid scalding.
  - Voltage applied to each terminal only can be that required in the Instruction Manual to prevent bursting, damage and so on.
  - Don't touch the main circuit boards CMOS and IC of the VFD since they are easily influenced and damaged by static electricity.
  - Only qualified professionals can install, debug and maintain the VFD.
  - Scrapped VFD shall be disposed as industrial wastes, and burning is prohibited.
  - After long-term storage, the VFD must undergo checking and commissioning before being used.
  - The VFD can be easily set for high-speed operation, before the setting, please check whether the characteristics of motor and machine are suitable for such high-speed operation.
-

---

**TABLE OF CONTENTS**

|   |          |
|---|----------|
| <b>NO.1 SAFETY CAUTIONS.....</b>                        | <b>1</b> |
| 1.1 UNPACKING INSPECTION.....                           | 1        |
| 1.1.1 <i>Inspection after unpacking</i> .....           | 1        |
| 1.1.2 <i>Introduction of V70 series nameplate</i> ..... | 1        |
| 1.1.3 <i>Model specification</i> .....                  | 1        |
| 1.2 INSTALLATION.....                                   | 1        |
| 1.3 USE.....  | 2        |
| 1.3.1 <i>Before energizing</i> .....                    | 2        |
| 1.3.2 <i>Energizing</i> .....                           | 2        |
| 1.3.3 <i>Running</i> .....                              | 2        |
| 1.4 STORAGE.....  | 2        |
| <b>NO.2 PRODUCT INTRODUCTION.....</b>                   | <b>4</b> |
| 2.1 SPECIFICATION OF V70 SERIES.....                    | 4        |
| 2.2 GENERAL SPECIFICATION OF THE PRODUCT.....           | 4        |
| <b>NO.3 WIRING.....</b>                                 | <b>7</b> |
| 3.1 ARRANGEMENT OF MAIN CIRCUIT TERMINALS.....          | 7        |
| 3.1.1 <i>Three-phase</i> .....                          | 7        |
| 3.1.2 <i>Single-phase</i> .....                         | 7        |
| 3.2 ARRANGEMENT OF CONTROL TERMINALS.....               | 7        |
| 3.3 DESCRIPTION OF MAIN CIRCUIT TERMINALS.....          | 7        |
| 3.4 DESCRIPTION OF CONTROL TERMINALS.....               | 7        |
| 3.5 DESCRIPTION OF JUMPER FUNCTION.....                 | 8        |
| 3.6 BASIC WIRING DIAGRAM.....                           | 9        |
| 3.6.1 <i>Main circuit wiring</i> .....                  | 10       |

|  |           |
|--|-----------|
| <b>NO.4 KEYBOARD DESCRIPTION.....</b>                          | <b>12</b> |
| 4.1 DESCRIPTION OF KEYBOARD.....                               | 12        |
| 4.2 DESCRIPTION OF INDICATOR FUNCTIONS.....                    | 13        |
| 4.3 DESCRIPTION OF DISPLAYED ITEMS.....                        | 13        |
| <b>NO.5 FUNCTION LIST.....</b>                                 | <b>15</b> |
| 5.1 BASIC FUNCTION PARAMETERS.....                             | 15        |
| 5.2 APPLICATION FUNCTION PARAMETERS.....                       | 16        |
| 5.3 FUNCTIONAL PARAMETERS OF INPUT/OUTPUT TERMINALS.....       | 17        |
| 5.4 FUNCTIONAL PARAMETERS OF ANALOG QUANTITY.....              | 20        |
| 5.5 FUNCTIONAL PARAMETERS OF MULTI-SEGMENT SPEED.....          | 20        |
| 5.6 PROTECTION FUNCTION PARAMETERS.....                        | 23        |
| 5.7 FUNCTION PARAMETERS OF CONSTANT-PRESSURE WATER SUPPLY..... | 24        |
| 5.8 MOTOR FUNCTION PARAMETERS.....                             | 24        |
| 5.9 PID FUNCTION PARAMETERS.....                               | 25        |
| 5.10 COMMUNICATION FUNCTION PARAMETERS.....                    | 26        |
| 5.11 MONITORING FUNCTION PARAMETERS.....                       | 26        |
| <b>NO.6 DETAILED FUNCTION DESCRIPTIONS.....</b>                | <b>28</b> |
| 6.1 BASIC FUNCTION PARAMETERS.....                             | 28        |
| EMERGENCY STOP DECELERATION TIME.....                          | 32        |
| 6.3 FUNCTIONAL PARAMETER OF INPUT/OUTPUT TERMINALS.....        | 37        |
| 6.4 FUNCTIONAL PARAMETER OF ANALOG QUANTITY.....               | 46        |
| 6.6 PROTECTION FUNCTION PARAMETERS.....                        | 56        |
| 6.7 FUNCTION PARAMETERS OF CONSTANT-PRESSURE WATER SUPPLY..... | 58        |
| 6.8 MOTOR FUNCTION PARAMETERS.....                             | 61        |
| 6.9 PID FUNCTION PARAMETERS.....                               | 64        |
| 6.10 COMMUNICATION FUNCTION PARAMETERS.....                    | 66        |
| 6.11 MONITORING FUNCTION PARAMETERS.....                       | 75        |

---

|   |           |
|---|-----------|
| <b>NO.7 MAINTENANCE AND FAULT INFORMATION.....</b>                    | <b>78</b> |
| 7.1 MAINTENANCE AND INSPECTION CAUTIONS.....                          | 78        |
| 7.2 REGULAR INSPECTION ITEMS.....                                     | 78        |
| 7.3 FAULT INFORMATION AND FAULT CLEARING.....                         | 78        |
| 7.4 FAULT AND ANALYSIS.....   | 80        |
| 7.5 COMMON ANOMALIES AND COUNTERMEASURES.....                         | 81        |
| <b>NO.8 SELECTION AND CONFIGURATION OF PERIPHERAL FACILITIES.....</b> | <b>83</b> |
| 8.1 OPTIONS.....  | 83        |
| 8.2 CONFIGURATION.....  | 83        |
| <b>ANNEX.....</b>   | <b>86</b> |
| ANNEX I EXAMPLES OF SIMPLE APPLICATION.....                           | 86        |
| ANNEX II EXTERNAL AND INSTALLATION DIMENSIONS.....                    | 89        |

## No.1 Safety cautions

### 1.1 Unpacking inspection

V70 series multi-function and high-performance VFD has passed test and quality inspection before delivery. After purchasing it and prior to unpacking, please check whether the package is damaged due to improper transportation, and whether the specification and model are in conformity with the ordered machine, in case of any problem, please contact the supplier.

#### 1.1.1 Inspection after unpacking

- (1) There is a VFD, an instruction manual, a warranty card and a certificate of approval inside.
- (2) Check the nameplate at side of the VFD to make sure the product in hand is the right one.

#### 1.1.2 Introduction of V70 series nameplate



Figure 1-1 Introduction of V70 series nameplate

#### 1.1.3 Model specification

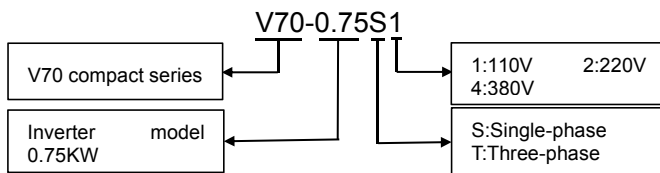

Figure 1-2 VFD Model Specification

### 1.2 Installation

- Ambient temperature ranges from -5℃ to 40℃, high temperature and moist shall be prevented with the humidity less than 90% (non-condensation).
- Electromagnetic interference shall be prevented and interference source shall be kept away.
- Water drop, steam, dust, cotton dust, and metal powder, as well as oil, salt and corrosive



gas shall be prevented entering.

- It is prohibited to install the VFD in environment with inflammable and explosive gas, as well as liquid and solid.
- It is unallowable to install air switch, contactor, capacitor or piezoresistor concerned and other devices at output side, so as to avoid VFD fault and damage to tripping protection or components.
- The VFD shall adopt independent power supply rather than sharing power supply with electric welder, so as to prevent the damage to VFD protection.
- To facilitate cooling and maintenance, the VFD shall be installed vertically with enough space around to ensure ventilation.
- Installation wall shall be made of non-combustible materials like iron plate which shall be prevented from vibration to cause damage to the VFD.
- If several VFDs are installed up and down in one cabinet, certain spacing shall be kept and baffle plate shall be set there between.

## **1.3 USE**

### **1.3.1 Before energizing**

- Voltage of the power supply selected must have the same specification with the input voltage of VFD.
- PE refers to earthing terminal, please make sure the motor and VFD are grounded properly to ensure safety.
- Do not set contactor between power supply and VFD to control startup or stop of VFD, otherwise life time of the inverted will be impacted.
- Wiring of main circuit terminal shall be correct, L1.L2.L3.L.N refer to power input terminals which are prohibited to be mixed with U.V.W., otherwise, damage to the VFD may be caused during energizing.

### **1.3.2 Energizing**

- It is prohibited to plug and unplug the connector on VFD to prevent surge entering the control panel and causing damage to the VFD.
- It is necessary to put the cover in place to prevent electric shock causing personal injury.

### **1.3.3 Running**

- It is prohibited to enable or disconnect motor unit during the running of VFD, so as to prevent overcurrent tripping even burning the main circuit.
- It is prohibited to remove the front cover of VFD during energizing to prevent electric shock causing personal injury.
- When the failure restart function is started, the motor will restart automatically after the running stops; please keep away from the machine at this time to avoid accident.
- Stop switch will not be enabled until being set, which is different from the emergency switch in use, please pay attention to it.

## **1.4 Storage**

- Temperature of the storage environment shall range from -20℃ to +65℃;
- Relative humidity of the storage environment shall range from 0% to 95% in dry place

without condensation or dust;

- There shall be no corrosive gas and liquid in the storage environment, it shall be put on shelter preferably with proper package;
- Long-term storage of VFD may cause deterioration of electrolytic capacitor, so it is necessary to switch it on over 5h once a year at least, and the voltage must rise to rated voltage value via a voltage regulator when inputting.



## No.2 Product Introduction

### 2.1 Specification of V70 series

| Model      | Input voltage     | Power (KW) | Horsepower (Hp) | Capacity of driver (KVA) | Output current (A) | Applicable motor (KW) |
|------------|-------------------|------------|-----------------|--------------------------|--------------------|-----------------------|
| V70-0.75S1 | Single-phase 110V | 0.75       | 1               | 2.0                      | 7                  | 0.75                  |
| V70-1.5S1  |                   | 1.5        | 2               | 2.8                      | 14                 | 1.5                   |
| V70-2.2S1  |                   | 2.2        | 3               | 4.4                      | 20                 | 2.2                   |
| V70-1.5S2  | Single-phase 220V | 1.5        | 2               | 2.8                      | 7                  | 1.5                   |
| V70-2.2S2  |                   | 2.2        | 3               | 4.4                      | 11                 | 2.2                   |
| V70-3.7S2  |                   | 3.7        | 5               | 6.8                      | 17                 | 3.7                   |
| V70-1.5T4  | Three-phase 380V  | 1.5        | 2               | 3.2                      | 4                  | 1.5                   |
| V70-2.2T4  |                   | 2.2        | 3               | 4.0                      | 5                  | 2.2                   |
| V70-3.7T4  |                   | 3.7        | 5               | 6.8                      | 8.5                | 3.7                   |
| V70-7.5T4  |                   | 7.5        | 10              | 14                       | 17.5               | 7.5                   |

### 2.2 General specification of the product

|   |  |  |
|---|--|--|
| Name                                    | V70 series   |  |
| Control mode                            | V/F , Vector control   |  |
| Input power                             | 380V power: 380±15%      220V power: 220±15%<br>110V power: 110±15%  |  |
| Four digital display & status indicator | Display frequency, current, rotating speed, voltage, counter, temperature, forward/reverse status, fault, etc. |  |
| Communication control                   | RS-485   |  |
| Operating temperature                   | -10 ~ 40°C   |  |
| Humidity                                | Relative humidity ranging from 0 to 95% (without condensation)   |  |
| Vibration                               | Below 0.5G   |  |
| Frequency control                       | Range  | 0.1 ~ 1000.0Hz   |
|   | Accuracy   | Digital type: 0.01% (-10 ~ 40°C); analog type: 0.1% (25±10°C)            |
|   | Setting resolution   | Digital type: 0.01Hz; analog type: 1% of the maximum operating frequency |

|                     |                                   |   |
|---------------------|-----------------------------------|---|
|                     | Output resolution                 | 0.01Hz  |
|                     | Keyboard setting mode             | Set as    directly |
|                     | Analog setting mode               | External voltage 0 ~ 5V, 0 ~ 10V, 4 ~ 20mA, 0 ~ 20mA.   |
|                     | Other functions                   | Three hopping frequencies (lower-frequency limit, startup frequency and stop frequency) can be set respectively   |
| General control     | Acceleration/deceleration control | 4 optional acceleration/deceleration time (0.1 ~ 6500 seconds)  |
|                     | Motor control mode                | V/F、vector control  |
|                     | Torque control                    | Torque can be set rising with the maximum of 10.0%, and it can reach 150% when starting at 1.0Hz  |
|                     | Multi-function input terminal     | 6-way programmable input; realize the functions like 8-segment speed control, program running, 4-segment acceleration/deceleration switching, UP, DOWN function, counter, external emergency stop, etc.   |
|                     | Multi-function output terminal    | 1-way programmable output; realize running, zero speed, counter, external exception, program running and other indications as well as alarm.  |
|                     | Other functions                   | Automatic voltage regulation (AVR), deceleration stop or free stop, DC brake, automatic reset and restart, frequency tracking, PLC program control, transverse control, draft control, automatic energy-saving running, carrier regulation (up to 20KHz), etc.        |
| Protection Function | Overload protection               | Electric relay protection motor driver (constant torque: 150% per minute, fans: 120% per minute).   |
|                     | FUSE protection                   | In case of fuse, the motor stops running  |
|                     | Over voltage                      | 110V: DC voltage>200V      220V: DC voltage>390V<br>380V: DC voltage>800V   |
|                     | Low voltage                       | 110V: DC voltage<100V      220V: DC voltage<200V<br>380V: DC voltage<400V   |
|                     | Restart after transient stop      | Restart after transient stop through frequency tracking mode  |

|  |                                  |  |
|--|----------------------------------|--|
|  | Stall prevention                 | Stall prevention during acceleration/deceleration  |
|  | Short circuit of output terminal | Electronic circuit protection  |
|  | Other functions                  | Overheating protection of radiating fin, reverse limit, direct startup after operating, fault reset, parameter locking, etc. |

## No.3 Wiring

### 3.1 Arrangement of main circuit terminals

#### 3.1.1 Three-phase

|    |    |    |     |    |   |   |   |
|----|----|----|-----|----|---|---|---|
| L1 | L2 | L3 | DC+ | DB | U | V | W |
|----|----|----|-----|----|---|---|---|

#### 3.1.2 Single-phase

|   |   |  |     |    |   |   |   |
|---|---|--|-----|----|---|---|---|
| L | N |  | DC+ | DB | U | V | W |
|---|---|--|-----|----|---|---|---|

[Note] Screws on main control board serve as PE terminals for that of 0.4 ~ 1.5kW.

### 3.2 Arrangement of control terminals

|    |    |    |                  |                  |     |     |    |    |              |
|----|----|----|------------------|------------------|-----|-----|----|----|--------------|
| FC | FB | FA | 485 <sub>+</sub> | 485 <sub>-</sub> | AO  | GND | X4 | X5 | X6/<br>Y1_FO |
|    |    |    | P12              | AI1              | AI2 | GND | X1 | X2 | X3           |

### 3.3 Description of main circuit terminals

| Symbol of terminal | Name of terminal      | Description   |
|--------------------|-----------------------|---|
| L1. L2. L3         | Input power terminal  | Connected to three-phase 380V power   |
| L. N               |                       | Connected to single-phase 220/110V power  |
| U. V. W            | VFD output terminal   | Connected to three-phase motor.   |
| DC+                | DC output + terminal  | DC bus output terminal is used for connecting external brake unit or common DC bus system. (DC- is not provided for partial models) |
| DC-                | DC output - terminal  |   |
| DB                 | Brake output terminal | Connecting brake resistor between DB and DC+.   |
| PE                 | Earthing terminal     | VFD housing earthing terminal must be earthed.  |

### 3.4 Description of control terminals

| Symbol of terminal | Name of terminal                             | Description                |
|--------------------|--|----------------------------|
| X1                 | Multi-function digital input terminals 1 ~ 6 | Factory setting is forward |
| X2                 |  | Factory setting is reverse |

|             |   |   |
|-------------|---|---|
| X3          |   | Factory setting is reset  |
| X4          |   | Factory setting is high speed   |
| X5          |   | Factory setting is medium speed   |
| X6/Y1_FO    |   | Factory setting is low speed  |
| GND         | Digital/analog/communication and power earthing terminals                       | Isolation of GND inside from PE   |
| P12         | +12V power supply   | Maximum output current: 150mA   |
| AI1         | Analog voltage input  | Input voltage range: 0 ~ +10V   |
| AI2         | Analog current/voltage input, selecting via jumper J3, default to current input | Input current range: 0 ~ +20mA<br>Input voltage range: 0 ~ +10V                                 |
| AO          | Analog voltage output, can choose voltage or current                            | Output voltage range: 0 ~ +10V<br>Input current range: 0/4 ~ +20mA                              |
| FA, FB, FC  | Multi-function relay output   | FA-FC: normally open,<br>FB-FC: normally close<br>Contact specification:<br>250VAC/3A, 30VDC/3A |
| 485+ , 485- | RS485 communication interface   | Available connection of 1 ~ 32 RS485 sites  |

### 3.5 Description of jumper function

| No. | Function   | Ex-factory setting |
|-----|--|--------------------|
| J1  | Selection of X1-X6 wiring mode: NPN PNP                  | PNP                |
| J2  | Selection of AO output: VO, voltage AO, current          | VO                 |
| J3  | Selection of AI2 input: V, voltage A, current            | A                  |
| J4  | RS485 communication interface terminator enabled: ON OFF | OFF                |
| J5  | Selection of X6 terminal function reuse: X6 Y1_PFO       | X6                 |

Wiring mode of multi-function digital input terminals X1-X6:

(1) When NPN type wiring mode is adopted for external equipment, leakage type logic is induced and the current flows out from input terminal (sourcing current) as shown in Figure 3-1, at the same time parameter F067=0 is required.

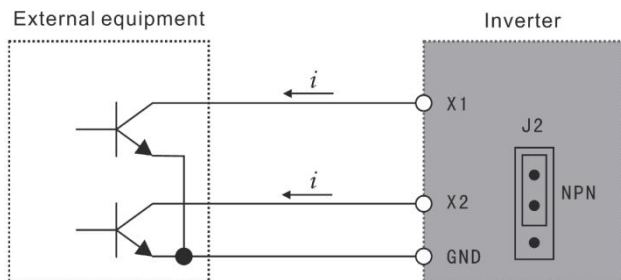

Figure 3-1 NPN Type Wiring Mode

(2) When PNP type wiring mode is adopted for external equipment, source-type logic is induced, and the current flows into from input terminal (sinking current) as shown in Figure 3-2, at the same time parameter F067=1 is required.

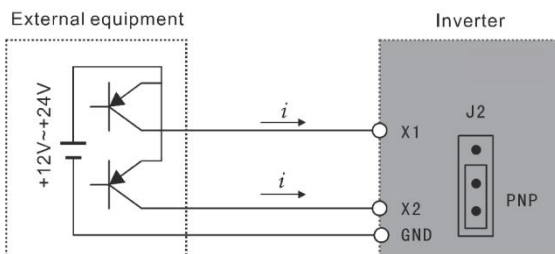

Figure 3-2 PNP Type Wiring Mode

### 3.6 Basic wiring diagram

VFD wiring involves main circuit and control circuit. The user can raise the cover of housing, at this time main circuit terminal and control circuit terminal shall be viewed, and the user must conduct correct connection as per wiring circuit below.

Figure 3-3 below refers to standard wiring diagram of V70 series.



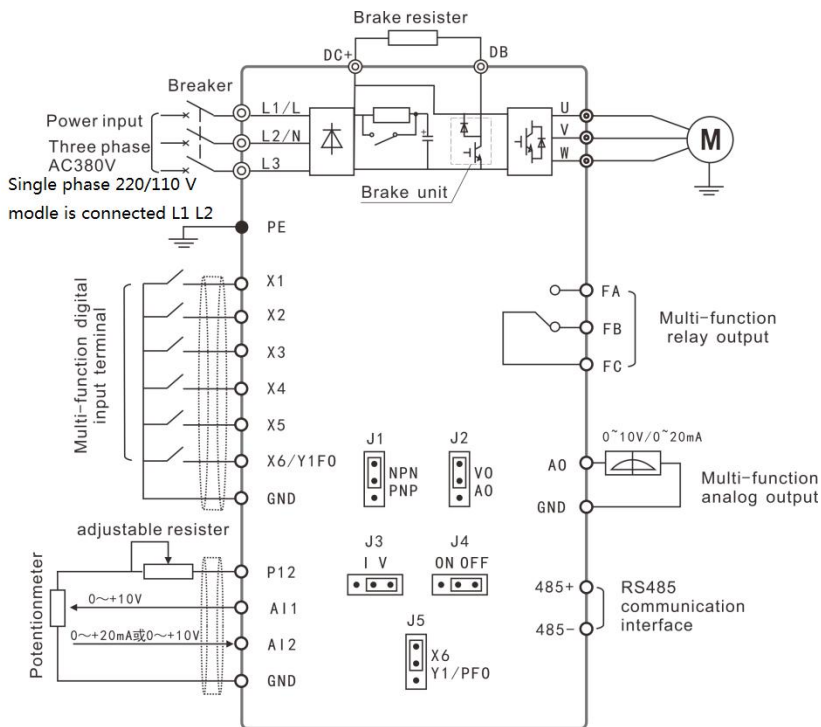

Figure 3-3 Standard Wiring of V70 series VFD

### 3.6.1 Main circuit wiring

- During wiring, please select wire diameter specification and conduct wiring as per those specified by electrical engineering laws so as to ensure the safety.
- For power supply wiring, prefer shielded wire or spool, and earth isolating layer or both ends of spool.
- Be sure to install air circuit breaker NFB between the power and input terminal (L1.L2.L3.L.N).  
(In case of applying leakage switch, please use the breaker with high frequency solution)
- Do not connect AC power to VFD output terminal (U.V.W).
- Prevent output wire touching metallic part of VFD housing; otherwise, earth short-circuit may be induced.
- Do not apply phase-shifting capacitor, LC, RC noise filter or other elements to output end of VFD.
- Indispensably make main circuit wiring of VFD away from other control equipment.

- When the wire between VFD and motor exceeds 15m (220V grade) or 30m (380V grade), extremely high dV/dT shall emerge inside motor coil and it shall produce damage to layer insulation of the motor, so it is necessary to use AC motor dedicated to VFD or install reactor onto VFD side.
- In case of long distance between VFD and motor, reduce carrier frequency, for the larger the carrier frequency is, the larger the higher harmonic leakage current becomes, which shall produce adverse effect on the VFD and other equipment.

### **1.Control circuit wiring**

- It is not allowed to place signal wire and main circuit wire inside the same slot.
- Supply cord of signal wire should be shielded wire with the size of 0.5-2.0mm.
- Control terminal on control board should be correctly used as required.

### **2.Earth wire**

- Please properly earth terminal PE of earth wire.  
220V grade: The third type earthing (earthing resistance is below 100)  
380V grade: Particularly the third type earthing (earthing resistance is below 10)
- Use earth wire as per fundamental length and size specified by electrical equipment technology.
- Absolutely avoid sharing earth electrode with welding machine, power generating machine and other large-scale power equipment and make earth wire away from power line of large-scale equipment as much as possible.
- Earth wire must be short to the utmost extent.



## No.4 Keyboard Description





### 4.1 Description of keyboard



Figure 4-1 V70 Series keyboard

Description of key function:



| Key graphics  | Key name | Function description   |
|---|----------|--|
|  | SET      | Enter into menu、enter into parameter or parameter data writing confirm                       |
|  | ESC      | Return to the status of "ENTER"  |
|  | UP       | parameters of function code、data etc increase/decrease, revise and select all kinds of modes |

|   |       |  |
|---|-------|--|
|  | DOWN  |  |
|  | SHIFT | Status monitor mode switch, parameter of third stage menu switch |
|  | DIR   | Change the running direction of motor                            |
|  | RUN   | Run command  |
|  | STOP  | Stop command/abnormal reset command                              |

## 4.2 Description of indicator functions

| Indicator          | Function description                            |
|--------------------|---|
| F/R                | Off: reverse      on: reverse                   |
| RUN                | Off: motor is stopped      on: motor is running |
| A                  | Unit of current                                 |
| V                  | Unit of voltage                                 |
| Hz                 | Unit of frequency                               |
| A + Hz combination | Time(S)   |
| V + Hz combination | Percentage(%)                                   |

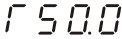
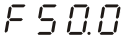
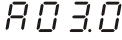
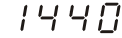
## 4.3 Description of displayed items

| Displayed content   | Description   |
|---|---|
|  | Output frequency is 50.0Hz at this time                         |
|  | Set frequency is 50.0Hz   |
|  | Output current is 3.0A at this time                             |
|  | Output speed is 1440r/min and speed light turns on at this time |
|  | DC voltage is 510V at this time                                 |

|   |  |
|---|--|
| The digital display shows the letter 'u' followed by the number '380'.  | AC voltage is 380V at this time        |
| The digital display shows the letter 't' followed by the number '35.0'. | VFD temperature is 35.0°C at this time |
| The digital display shows the number '0' followed by the number '105'.  | Counter value is 105 at this time      |
| The digital display shows the letter 'n' followed by the number '50.0'. | PID target value is 50.0%              |
| The digital display shows the letter 'r' followed by the number '48.0'. | PID feedback value is 48.0%            |

## No.5 Function List

Description of special symbols:

\* indicates that this parameter content has various set values or it shall be specifically set based on actual situation.

Ex-factory value refers to parameter value set during delivery of VFD or parameter value refreshed while the user restores ex-factory operation.

Alteration refers to alternative attribute of the parameter. ○ indicates that the alteration is available during shutdown and operating, × indicates that the alteration is unavailable during operating, and Δ refers to read-only parameter which cannot be altered by the user.

### 5.1 Basic function parameters

| Function code | Name of function                   | Setting range and data content   | Ex-factory value | Alteration |
|---------------|------------------------------------|--|------------------|------------|
| F000          | Parameter locking                  | 0: Invalid 1: Valid  | 0                | ×          |
| F001          | Control mode                       | 0: keyboard<br>1: External terminal<br>2: Communication port   | 0                | ×          |
| F002          | Frequency setting selection        | 0: keyboard<br>1: AI1<br>2: Communication port<br>3: Operate potentiometer<br>4: AI2<br>5: PFI<br>6: AI1+AI2 | 3                | ×          |
| F003          | Main frequency                     | 0.0~1000.0 Hz  | *                | ○          |
| F004          | Reference frequency                | 0.1~1000.0 Hz  | 50.0             | ×          |
| F005          | Maximum operating frequency        | 10.0~1000.0 Hz   | 50.0             | ×          |
| F006          | Intermediate frequency             | 0.1~1000.0 Hz  | 5.0              | ×          |
| F007          | Minimum frequency                  | 0.1~20.0 Hz  | 0.50             | ×          |
| F008          | Maximum voltage                    | 0.1V~*   | 220/380          | ×          |
| F009          | Intermediate voltage               | 0.1V~*   | *                | ×          |
| F010          | Low-frequency torque boost voltage | 0.1V~50.0V   | *                | ×          |
| F011          | Lower frequency limit              | 0.0~1000.0 Hz  | 0                | ○          |
| F012          | Drive control mode                 | 0: VF 1: vector control  | 1                | ×          |
| F013          | Parameter resetting                | 8 restore ex-factory value   | 00               | ×          |

|      |   |   |     |   |
|------|---|---|-----|---|
| F014 | Acceleration time I                                 | 0.1~650.00s   | *   | ○ |
| F015 | Deceleration time I                                 | 0.1~650.00s   | *   | ○ |
| F016 | Acceleration time II                                | 0.1~650.00s   | *   | ○ |
| F017 | Deceleration time II                                | 0.1~650.00s   | *   | ○ |
| F018 | Acceleration time III                               | 0.1~650.00s   | *   | ○ |
| F019 | Deceleration time III                               | 0.1~650.00s   | *   | ○ |
| F020 | Acceleration time IV<br>(jogging acceleration time) | 0.1~650.00s   | *   | ○ |
| F021 | Deceleration time IV<br>(jogging acceleration time) | 0.1~650.00s   | *   | ○ |
| F022 | Emergency stop deceleration time                    | 0.1~650.00s<br>0.00 emergency stop by costing to stop | 0.0 | ○ |

## 5.2 Application function parameters

| Function code | Name of function                            | Setting range and data content                                  | Ex-factory value | Alteration |
|---------------|---|---|------------------|------------|
| F023          | Reverse prohibit                            | 0: Reverse prohibit<br>1: Reverse allow                         | 1                | ×          |
| F024          | Stop key is valid or not                    | 0: STOP invalid 1: STOP valid                                   | 1                | ×          |
| F025          | Start mode                                  | 0: Start from starting frequency<br>1: Frequency tracking start | 0                | ×          |
| F026          | Reverse prohibit                            | 0: Reverse prohibit<br>1: Reverse allow                         | 0                | ×          |
| F027          | Starting frequency                          | 0.1~30.0 Hz   | 0.5              | ×          |
| F028          | Stop frequency                              | 0.1~30.0 Hz   | 0.5              | ×          |
| F029          | Start braking time                          | 0.0~25.0s   | 0.0              | ×          |
| F030          | Stop braking time                           | 0.0~25.0s   | 0.0              | ×          |
| F031          | DC braking level                            | 0.0~20.0%   | 2.0              | ×          |
| F032          | Frequency tracking time                     | 0.1~20.0s   | 5.0              | ×          |
| F033          | Current tracking frequency level            | 0~200%  | 150              | ×          |
| F034          | Voltage rise time during frequency tracking | 0.1~10.0s   | 0.5              | ○          |

|           |   |               |     |   |
|-----------|---|---------------|-----|---|
| F035      | Percentage of start voltage during frequency tracking | 1~20%         | 5   | × |
| F036      | Voltage increment during frequency tracking           | 1~20V         | 10  | × |
| F037-F038 |   | Reserve       |     |   |
| F039      | Starting frequency of DC BRAKING                      | 0~15          | 0   | × |
| F040      | Frequency resolution                                  | 0.0~1000.0 Hz | *   | ○ |
| F041      | Carrier frequency                                     | 0~15          | *   | × |
| F042      | Jogging frequency                                     | 0.0~1000.0 Hz | 5.0 | ○ |
| F043      | S curve time  | 0.0~6500.0s   | 0.0 | ○ |

### 5.3 Functional parameters of input/output terminals

| Function code | Function name    | Setting range and data content  | Ex-factory value | Alteration |
|---------------|------------------|---|------------------|------------|
| F044          | FOR(X1) function | 0: Invalid  | 02               | ×          |
| F045          | REV(X2) function | 1: Run  | 03               | ×          |
| F046          | RST(X3) function | 2: Forward  | 14               | ×          |
| F047          | SPH(X4) function | 3: Reverse  | 22               | ×          |
| F048          | SPM(X5) function | 4: Stop   | 23               | ×          |
| F049          | SPL(X6) function | 5: Forward/reverse<br>6: Inching<br>7: Inching forward<br>8: Inching reverse<br>9: External control timer I<br>10: External control timer II<br>11: Setting frequency is forced to F003<br>12: Radiator or motor overheating<br>13: Emergency stop<br>14: Reset<br>15-16: Reserve<br>17: Acceleration/deceleration time selection I<br>18: Acceleration/deceleration time selection II<br>19: Multi-segment speed I | 24               | ×          |



V70 Series High Performance Vector Control Mini VFD

|      |   |  |    |   |
|------|---|--|----|---|
|      |   | 20: Multi-segment speed II<br>21: Multi-segment speed III<br>22: High speed<br>23: Medium speed<br>24: Low speed<br>25: PID allowed<br>26: Multi-segment speed IV<br>27: UP<br>28: DOWN<br>29: Draft allowed<br>30: Reserve<br>31: Pulse counter<br>32: Pulse counter resets   |    |   |
| F050 | Y1 output function                      | 0: Invalid   | 01 | ○ |
| F051 | Y2 output function                      | 1: Indication during running   | 05 | ○ |
| F052 | Output function (KA & KC are terminals) | 2: Zero-speed indication<br>3: Fault indication  | 00 | ○ |
| F053 | Output function (FA, FB & FC terminals) | 4: DC braking indication<br>5: Setting frequency arrival indication<br>6: Accelerating indication<br>7: Decelerating indication<br>8: Frequency consistency arrival I indication<br>9: Frequency consistency arrival II indication<br>10: Motor overload indication<br>11: Over-torque indication<br>12: VFD overload indication<br>13: Pulse setting counter arrival indication<br>14: Pulse middle counter arrival indication<br>15: External control timer I arrival indication<br>16: External control timer II arrival indication<br>17: Low-voltage indication<br>18: Internal control multi-segment speed stage completion indication<br>19: Internal control multi-segment speed<br>20: 4~20mA off line indication | 03 | ○ |

|      |  |   |      |   |
|------|--|---|------|---|
|      |  | 21~23: reserve<br>24: ED0<br>25: auxiliary pump 1 motion indication<br>26: auxiliary pump 2 motion indication<br>27: draft finishing indication<br>28: PID lower limit alarm indication<br>29: PID up limit alarm indication<br>30: braking resistance motion indication<br>31: electromagnetism relay motion indication<br>32: fan motion indication |      |   |
| F054 | AO output function   | 0: output frequency<br>1: output current<br>2: DC bus voltage<br>3: output voltage  | 0    | ○ |
| F055 | AO analog output gain  | 0~400%  | 100  | ○ |
| F056 | Hopping frequency 1  | 0.0 ~ 1000.0Hz  | 0.00 | ○ |
| F057 | Hopping frequency 2  | 0.0 ~ 1000.0Hz  | 0.00 | ○ |
| F058 | Hopping frequency 3  | 0.0 ~ 1000.0Hz  | 0.00 | ○ |
| F059 | Range of hopping frequency   | 0.1 ~ 10.0 Hz   | 0.50 | ○ |
| F060 | Frequency consistency I<br>(constant pressure water supply high speed frequency) | 0.0~1000.0 Hz   | 0.00 | ○ |
| F061 | Frequency consistency II<br>(constant pressure water supply low speed frequency) | 0.0~1000.0 Hz   | 0.00 | ○ |
| F062 | Frequency Consistency range setting  | 0.1~10.0 Hz   | 0.50 | ○ |
| F063 | Timer I  | 0.1 ~ 10.0s   | 0.1  | × |

|      |   |  |      |   |
|------|---|--|------|---|
| F064 | Timer II  | 1~ 100s  | 1    | × |
| F065 | Count value                                       | 0~65500  | 0    | ○ |
| F066 | Value of middle counter                           | 0~65500  | 0    | ○ |
| F067 | Digital input terminal Positive & negative logic  | 0: Positive logic, wiring mode NPN<br>1: Negative logic, wiring mode PNP | 01   | × |
| F068 | Digital input terminal dithering elimination time | 0~60000ms  | 20   | ○ |
| F069 | PFO maximum frequency                             | 1.0~10.0   | 10.0 | × |

#### 5.4 Functional parameters of analog quantity

| Function code | Function name                                       | Setting range and data content  | Ex-factory value | Alteration |
|---------------|---|---|------------------|------------|
| F070          | Input channel selection for analog quantity         | unit's digit:<br>0: 0~10V 1: 0~5V<br>Ten's digit:<br>0: 0~20mA/0~10V<br>1: 4~20mA/2~10V | 00               | ×          |
| F071          | Filtering time of analog quantity                   | 0~1000ms  | 20               | ×          |
| F072          | High-end frequency of analog frequency              | 0.0~1000.0 Hz   | 50.00            | ×          |
| F073          | Low-end frequency of analog quantity                | 0.0~1000.0 Hz   | 0                | ×          |
| F074          | Bias direction of high-end frequency                | 0: Positive<br>1: Negative  | 0                | ×          |
| F075          | Bias direction of low-end frequency                 | 0: Positive<br>1: Negative  | 0                | ×          |
| F076          | Selectable negative bias reverse of analog quantity | 0: Irreversible<br>1: Reversible  | 0                | ×          |
| F077          | UP.DOWN memory function selection                   | 0: Not memorized<br>1: Memorized  | 0                | ×          |
| F078          | UP.DOWN increment selection                         | 0: 0.1Hz 1: 1.0Hz   | 1                | ×          |
| F079          | UP.DOWN increment multiple                          | 1~250   | 1                | ×          |

#### 5.5 Functional parameters of multi-segment speed

## V70 Series High Performance Vector Control Mini VFD

| Function code | Function description   | Setting range and data content  | Ex-factory value | Alteration |
|---------------|--|---|------------------|------------|
| F080          | Selection of multi-segment speed mode  | 0:Normal operation<br>1:Internally controlled 16-segment speed<br>2:Externally controlled 4-segment speed<br>3:Externally controlled 16-segment speed<br>4:Externally controlled 4-segment speed(command valid automatically)<br>5: Externally controlled 6-segment speed(command | 2                | ×          |
| F081          | Internally controlled multi-segment speed Selection of operation mode        | 0: Stop after operating for one cycle<br>1: Circulating operation<br>2: Stop after automatically operating for one cycle (STOP interval)  | 0                | ×          |
| F082          | Speed operation directions of first internally controlled 8 segments         | 0~255 (0: forward 1: reverse)   | 0                | ×          |
| F083          | Speed operation directions of last internally controlled 8 segments          | 0~255 (0: forward 1: reverse)   | 0                | ×          |
| F084          | Acceleration/deceleration time of the first internally controlled 8 segments | 0~65535   | 0                | ×          |
| F085          | Acceleration/deceleration time of the last internally controlled 8 segments  | 0~65535   | 0                | ×          |

## V70 Series High Performance Vector Control Mini VFD

|      |   |               |       |   |
|------|---|---------------|-------|---|
| F086 |   | 0.0~1000.0 Hz | 15.00 |   |
| F087 | Frequency II setting                                    | 0.0~1000.0 Hz | 20.00 |   |
| F088 | Frequency III setting                                   | 0.0~1000.0 Hz | 25.00 |   |
| F089 | Frequency IV setting                                    | 0.0~1000.0 Hz | 30.00 |   |
| F090 | Frequency V setting                                     | 0.0~1000.0 Hz | 35.00 |   |
| F091 | Frequency VI setting                                    | 0.0~1000.0 Hz | 40.00 |   |
| F092 | Frequency VIII setting                                  | 0.0~1000.0 Hz | 0.50  |   |
| F093 | Frequency IX setting                                    | 0.0~1000.0 Hz | 10.00 | ○ |
| F094 | Frequency X setting                                     | 0.0~1000.0 Hz | 15.00 |   |
| F095 | Frequency XI setting                                    | 0.0~1000.0 Hz | 20.00 |   |
| F096 | Frequency XII setting                                   | 0.0~1000.0 Hz | 25.00 |   |
| F097 | Frequency XIII setting                                  | 0.0~1000.0 Hz | 30.00 |   |
| F098 | Frequency XIV setting                                   | 0.0~1000.0 Hz | 35.00 |   |
| F099 | Frequency XVI setting                                   | 0.0~1000.0 Hz | 40.00 |   |
| F100 |   | 0.0~1000.0 Hz | 45.00 |   |
|      | Internally controlled<br>multi-segment speed timer I    |               |       |   |
| F101 | Internally controlled<br>multi-segment speed timer II   | 0.0~6500.0s   | 10.0  |   |
| F102 | Internally controlled<br>multi-segment speed timer III  | 0.0~6500.0s   | 10.0  |   |
| F103 | Internally controlled<br>multi-segment speed timer IV   | 0.0~6500.0s   | 0.0   |   |
| F104 | Internally controlled<br>multi-segment speed timer V    | 0.0~6500.0s   | 0.0   |   |
| F105 | Internally controlled<br>multi-segment speed timer VI   | 0.0~6500.0s   | 0.0   |   |
| F106 | Internally controlled<br>multi-segment speed timer VII  | 0.0~6500.0s   | 0.0   |   |
| F107 | Internally controlled<br>multi-segment speed timer VIII | 0.0~6500.0s   | 0.0   |   |
| F108 | Internally controlled<br>multi-segment speed timer IX   | 0.0~6500.0s   | 0.0   | ○ |
| F109 | Internally controlled<br>multi-segment speed timer X    | 0.0~6500.0s   | 0.0   |   |
| F110 | Internally controlled<br>multi-segment speed timer XI   | 0.0~6500.0s   | 0.0   |   |
| F111 | Internally controlled<br>multi-segment speed timer XII  | 0.0~6500.0s   | 0.0   |   |
| F112 | Internally controlled<br>multi-segment speed timer XIII | 0.0~6500.0s   | 0.0   |   |
| F113 | Internally controlled<br>multi-segment speed timer XIV  | 0.0~6500.0s   | 0.0   |   |
| F114 | Internally controlled<br>multi-segment speed timer XV   | 0.0~6500.0s   | 0.0   |   |
| F115 | Internally controlled<br>multi-segment speed timer XVI  | 0.0~6500.0s   | 0.0   |   |
| F116 | Internally controlled<br>multi-segment speed timer XVII | 0.0~6500.0s   | 0.0   |   |

|      |  |     |   |   |
|------|--|-----|---|---|
|      | multi-segment speed timer<br>XII<br>Internally controlled<br>multi-segment speed timer<br>XIII<br>Internally controlled<br>multi-segment speed timer<br>XIV<br>Internally controlled<br>multi-segment speed timer<br>XV<br>Internally controlled<br>multi-segment speed timer<br>XVI |     |   |   |
| F117 | Internally controlled<br>multi-segment speed<br>memory function(UP.DOWN<br>power fault reserve)  | 0~1 | 0 | × |

## 5.6 Protection function parameters

| Function code | Function   | Setting range & function description | Ex-factory value | Alteration |
|---------------|--|--------------------------------------|------------------|------------|
| F118          | Selection of over-voltage stall                  | 0~1                                  | 1                | ×          |
| F119          | Stalling level during accelerating               | 0~200%                               | 150              | ×          |
| F120          | Stalling level during constant speed             | 0~200%                               | 150              | ×          |
| F121          | Stalling deceleration time during constant speed | 0.1~25.5s                            | 5                | ○          |
| F122          | Prevent of over-voltage stalling level           | 200~800V                             | Motor type       | ×          |
| F123          | Selection of over-torque detection mode          | 0~3                                  | 0                | ×          |
| F124          | Selection of over-torque detection mode          | 0~200%                               | 0                | ×          |
| F125          | Over-torque detection level                      | 0.1~20.0s                            | 1.0              | ×          |

|      |                            |  |            |   |
|------|----------------------------|--|------------|---|
| F126 | Over-torque detection time | 0~1  | 0          | × |
| F127 | Pulse counter memory       | 0~65000  | 0          | × |
| F128 | Cooling fan control        | 0: running always<br>1: control by running command,<br>delayed 30S after turning off | 0          | × |
| F129 | Dynamic braking voltage    | 0~800V   | Motor type | × |

## 5.7 Function parameters of constant-pressure water supply

| Function code | Function description                | Setting range & function description | Ex-factor y value | Alteration |
|---------------|-------------------------------------|--------------------------------------|-------------------|------------|
| F130          | Quantity of auxiliary               | 0~2                                  | 0                 | ×          |
| F131          | Continuous time of auxiliary pump   | 1~9000min                            | 60                | ×          |
| F132          | Interlocking time of auxiliary pump | 1~250s                               | 5                 | ○          |
| F133          | High-speed operating time           | 1~250s                               | 60                | ○          |
| F134          | Low-speed operating time            | 1~250s                               | 60                | ○          |
| F135          | Stop pressure level                 | 1~150%                               | 95                | ○          |
| F136          | Stop level continuous time          | 1~250s                               | 30                | ○          |
| F137          | Wake-up level                       | 1~150%                               | 80                | ○          |
| F138          | Sleep frequency                     | 0.0~1000.0Hz                         | 20.00             | ○          |
| F139          | Continuous time of sleep frequency  | 1~250s                               | 20                | ○          |

## 5.8 Motor function parameters

| Function code | Function description          | Setting range & function description | Ex-factor y value | Alteration |
|---------------|-------------------------------|--------------------------------------|-------------------|------------|
| F140          | Rated power of motor          | Set as per motor nameplate           | *                 | ×          |
| F141          | Rated voltage of motor        | Set as per motor nameplate           | *                 | ×          |
| F142          | Rated current of motor        | Set as per motor nameplate           | *                 | ×          |
| F143          | Number of motor poles         | 02~22                                | 04                | ×          |
| F144          | Rated rotating speed of motor | 00~9999                              | 1440              | ×          |

|      |   |                                  |       |   |
|------|---|----------------------------------|-------|---|
| F145 | Automatic torque compensation             | 0.0~10.0%                        | 2.0   | × |
| F146 | Motor no-load current                     | 0~100%                           | 40    | × |
| F147 | Motor slip compensation                   | 0~1.0                            | 0.000 | × |
| F148 | Motor slip compensation maximum frequency | 0.0~20.0Hz                       | 2.0   | × |
| F149 | Motorslip compensation filtering time     | 0~200ms                          | 10    | ○ |
| F150 | AVR function                              | 0 ~ 1                            | 1     | × |
| F151 | Automatic energy-saving function          | 0.0~20.0%                        | 0.0   | × |
| F152 | Fault restart time                        | 0.2~25.0s                        | 1.0   | ○ |
| F153 | Selection of transient stop restart       | 0: Invalid 1: Frequency tracking | 0     |   |
| F154 | Allowed power fault time                  | 0.1~5.0s                         | 0.5   | × |
| F155 | Times of fault restart                    | 0 ~ 10                           | 00    |   |

## 5.9 PID function parameters

| Function code | Function name           | Setting range & content description  | Ex-factor y value | Alteration |
|---------------|-------------------------|--|-------------------|------------|
| F156          | Proportional constant P | 0.0~1000.0%  | 100.0             | ○          |
| F157          | Integration time I      | 0.1~3600.0s 0 close integration  | 2.0               | ○          |
| F158          | Derivation time D       | 0.01~10.00s, 0 close derivation  | 0                 | ○          |
| F159          | target value            | 0.0~100.0%   | 0                 | ○          |
| F160          | PID channel setting     | Unit's digit: PID setting channel<br>0:set by F159<br>1: AI1<br>2: AI2<br>Ten's digit: PIDfeedback channel<br>0:AI1 1: AI2 | 10                | ×          |
| F161          | PID up limit            | 0~100%   | 100               | ○          |
| F162          | PID lower limit         | 0~100%   | 0                 | ○          |



## 5.10 Communication function parameters

| Function code | Function name                       | Setting range and content description | Ex-factor y value | Alteration |
|---------------|-------------------------------------|---------------------------------------|-------------------|------------|
| F163          | Communication address               | 0~250                                 | 1                 |            |
| F164          | Communication transmission speed    | 0~3                                   | 2                 | ×          |
| F165          | Communication data mode             | 0~5                                   | 3                 |            |
| F166~F168     |                                     | reserve                               |                   |            |
| F169          | Selection of communication protocol | 0: Standard Modbus Agreement          | 0                 | ×          |

## 5.11 Monitoring function parameters

| Function code | Function                         | Setting range and content description  | Ex-factory value | Alteration |
|---------------|----------------------------------|--|------------------|------------|
| F170          | Selection of extension display 1 | 0~11<br>0: not displayed   | 4                |            |
| F171          | Selection of extension display 2 | 1: PID feedback value<br>2: operation speed<br>3: PID target value<br>4: bus voltage<br>5: heat sink temperature<br>6: counter<br>7: output torque<br>8: input terminal status<br>9: AI1 10: AI2 11: PFI | 5                | ○          |
| F172          | Fault clearing                   | 00-10 (01 refers to fault clearing)  | *                |            |
| F173          | Rated voltage of VFD             | Set as per machine model   | *                |            |
| F174          | Rated current of VFD             | Set as per machine model   | *                | △          |
| F175          | Type of VFD                      | 0: Constant torque 1: Fan model  | 0                |            |
| F176          | Frequency standard of VFD        | 0: 50Hz 1: 60Hz  | 0                |            |
| F177          | Unexpected error 1               | Note:<br>—means no fault record  | —                | △          |
| F178          | Unexpected error 2               |  | —                |            |
| F179          | Unexpected error 3               |  | —                |            |
| F180          | Unexpected error 4               |  | —                |            |

## V70 Series High Performance Vector Control Mini VFD

|           |                                       |  |       |   |
|-----------|---------------------------------------|--|-------|---|
| F181      | Software version No.                  | 00~02  | 00    | ○ |
| F182      | Running time                          | 0~3600s  |       | △ |
| F183      | Cumulative running time               | 0~65535h   |       | △ |
| F184      | RPM display factor                    | 0.000~9.999  | 1.000 | ○ |
| F185      | Selection of starting pre-set display | 0~5<br>0: output frequency<br>1: setting frequency<br>2: output current<br>3: output voltage<br>4: setting by F170<br>5: setting by F171 | 0     | ○ |
| F186~F250 |                                       | reserve  |       |   |

## No.6 Detailed Function Descriptions

### 6.1 Basic function parameters

| F000              | Setting range | Unit | Ex-factory value | Change |
|-------------------|---------------|------|------------------|--------|
| Parameter locking | 0-1           | 1    | 0                | ×      |

0: Invalid

1: Valid (parameter locking, meaning other parameters are unchangeable except this parameter.)

This parameter can avoid mistake operation of non-operators which may cause unnecessary danger and mistake. But after locking parameters, the current frequency can be changed through keys ▲ and ▼.

| F001                      | Setting range | Unit | Ex-factory value | Alteration |
|---------------------------|---------------|------|------------------|------------|
| Selection of control mode | 0-2           | 1    | 0                | ×          |

0: Keyboard setting (Operating command is set by keyboard.)

1: External terminals setting (Operating command is set by 6-way programmable input terminals.)

2: Communication interface setting (Operating command is set by transmission of communication interface)

| F002                        | Setting range | Unit | Ex-factory value | Alteration |
|-----------------------------|---------------|------|------------------|------------|
| Frequency setting selection | 0-3           | 1    | 0                | ×          |

0: Keyboard setting (F003 of former operating frequency is set by keyboard.)

1: Analog quantity setting (Former operating frequency is controlled by input analog signals and signal type is decided by F070. Refer to F070-F076 for relevant parameters.)

2: Communication interface setting (Current operating frequency is set by serial port communication.)

3: Potentiometer of keyboard (Current operating frequency is set by potentiometer knob on keyboard.)

5: Inpulse input setting

6: Analog quantity AI1+AI2 setting

| F003           | Setting range | Unit    | Ex-factor | Alteration |
|----------------|---------------|---------|-----------|------------|
| Main frequency | 0.0~1000.0 Hz | 0.01 Hz | *         | ○          |

In case that frequency option is set by keyboard, the frequency operates with set value of F003. During operating, the current operating frequency can be changed with keys ▲ and ▼. In multi-segment operation, main frequency is taken as frequency I. If F002 is set as 1, i.e. the external analog quantity is set, the frequency I is set by analog quantity of external terminals. Main frequency setting is limited by maximum operating frequency.

Relevant parameters: F002 and F080. These parameters are adjustable during operating.

| F004                | Setting range | Unit    | Ex-factory | Alteratio |
|---------------------|---------------|---------|------------|-----------|
| Reference frequency | 0.1~1000.0Hz  | 0.01 Hz | 50.00      | ×         |

This setting must be conducted as per the motor's rated running voltage frequency on motor nameplate. Generally, the frequency setting value shall not be changed at will. In case of being equipped with special motor, please set properly as per the motor parameter characteristics, otherwise, the equipment will be damaged.

| F005                        | Setting range  | Unit    | Ex-factory | Alteration |
|-----------------------------|----------------|---------|------------|------------|
| Maximum operating frequency | 10.0~1000.0 Hz | 0.01 Hz | 50.00      | ×          |

This parameter decides the maximum operating frequency of the VFD.

| F006                   | Setting range | Unit    | Ex-facto | Alteratio |
|------------------------|---------------|---------|----------|-----------|
| Intermediate frequency | 0.1~1000.0 Hz | 0.01 Hz | 5.0      | ×         |

This parameter can set the intermediate frequency value in any V/F curve. Improper setting will cause insufficient start up torque of VFD or motor over current and even tripping of VFD. The setting value of intermediate frequency is limited by that of reference frequency.

| F007              | Setting range | Unit   | Ex-factor | Alteration |
|-------------------|---------------|--------|-----------|------------|
| Minimum frequency | 0.1~200.0 Hz  | 0.1 Hz | 0.5       | ×          |

This parameter decides the minimum startup frequency value in V/F curve.

| F008            | Setting range | Unit | Ex-factory | Alteration |
|-----------------|---------------|------|------------|------------|
| Maximum voltage | 0.1-*         | 0.1V | 220/380    | ×          |

This value shall be set as per rated value on motor's nameplate. The ex-factory value of 380V grade is 380V while that of 220V grade is 220V and 110V grade is 110V. This parameter setting range is limited by voltage grade of VFD. And at the sites where motor is relatively far away from VFD, this value can be appropriately increased.

| F009                 | Setting range | Unit | Ex-factor | Alteration |
|----------------------|---------------|------|-----------|------------|
| Intermediate voltage | 0.1~510.0V    | 0.1V | *         | ×          |

This parameter can set intermediate voltage values in any V/F curve. Improper setting may cause motor over current or insufficient torque and even VFD tripping. Augmenting intermediate voltage may augment the output torque and the output current will increase at the same time. When modifying this parameter, please monitor the output current so as to avoid over current and tripping of VFD.

Intermediate voltage setting value is limited by maximum voltage setting value. When intermediate voltage increases to a certain value, the torque compensation may lose its

utility. When adjusting this parameter, slowly increase the output current of VFD from small to large as per the mechanical load until it meets the startup requirements and do not improve the current with large amplitude, otherwise VFD tripping or equipment damage may occur.

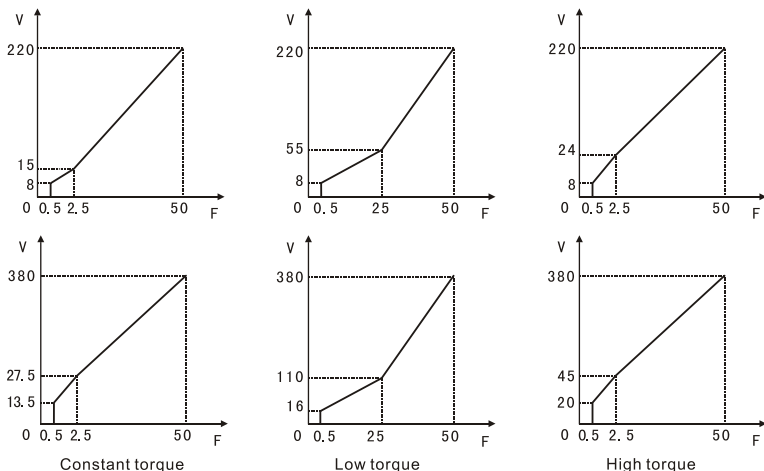

Figure 6-1 Common Curves and Setting Values

| F010                                    | Setting value | Unit | Ex-factor | Alteration |
|---|---------------|------|-----------|------------|
| Booster voltage of low-frequency torque | 0.1~380.0V    | 0.1V | *         | ×          |

This parameter sets the lowest startup voltage value in V/F curve. F010 setting value is limited by voltage of maximum operating frequency. This parameter can compensate the insufficient torque at low frequency, but the torque compensation shall not be too large and shall be set from small to large slowly according to actual situations. Insufficient compensation may cause insufficient torque when motor is at low frequency, while excessive compensation may cause excessive torque and generate impact to machinery and even may cause VFD tripping if severe. V/F curves are determined by F006-F010. This manual supplies several common V/F curves for reference, such as Figure 6-1. Specific curves shall be set as per mechanical load characteristics.

| F011                     | Setting range | Unit    | Ex-factory | Alteration |
|--------------------------|---------------|---------|------------|------------|
| Lower limit of frequency | 0.0~1000.0    | 0.01 Hz | 0.00       | ○          |

The purpose of lower limit of frequency is to prevent misoperation of site personnel and avoid overheat or other mechanical fault due to too low running frequency of motor. The

setting of lower limit of frequency must be smaller than the setting value of upper limit of frequency.

|                    |                              |
|--------------------|------------------------------|
| F012               |                              |
| Drive control mode | 0: VF      1: vector control |

| F013            | Setting range | Unit | Ex-factor | Alteration |
|-----------------|---------------|------|-----------|------------|
| Parameter reset | 00~10         | 1    | 00        | ×          |

If the setting of parameter values is improper or abnormal, set them as 08 and reset it after the ex-factory value is recovered. After being locked (when F000=1), the parameters can not be reset unless they are unlocked. Relevant parameter: F000.

| F014  | Setting range | Unit | Ex-factory value | Alteration |
|---|---------------|------|------------------|------------|
| Acceleration time I                                 | 0.1~6500.0s   | 0.1s | *                | ○          |
| F015  |               |      |                  |            |
| Deceleration time I                                 |               |      |                  |            |
| F016  |               |      |                  |            |
| Acceleration time II                                |               |      |                  |            |
| F017  |               |      |                  |            |
| Deceleration time II                                |               |      |                  |            |
| F018  |               |      |                  |            |
| Acceleration time III                               |               |      |                  |            |
| F019  |               |      |                  |            |
| Deceleration time III                               |               |      |                  |            |
| F020  |               |      |                  |            |
| Acceleration time IV<br>(Jogging acceleration time) |               |      |                  |            |
| F021  |               |      |                  |            |
| Deceleration time IV<br>(Jogging deceleration time) |               |      |                  |            |

Acceleration time refers to the time required by the VFD to accelerate from 0Hz to maximum operating frequency. Refer to t1 in Figure 6-2 for details; deceleration time refers to the time required by the VFD to decelerate from maximum operating frequency to 0Hz. Refer to t2 in

Figure 6-2 for details.

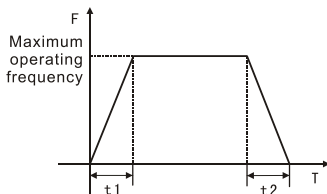

Figure 6-2 Acceleration/deceleration Time Curves

V70 series of VFDs define four kinds of acceleration/deceleration time in all from acceleration/deceleration I to IV. Users can select different acceleration/deceleration time through the corresponding function switching of acceleration/deceleration time at external switch terminals as required; and select different acceleration/deceleration time through relevant parameters of internally controlled multi-segment speed during internally controlled multi-segment speed operation.

Generally, the VFD defaults acceleration/deceleration time I. The ex-factory value of acceleration/deceleration time I is set as per model and acceleration/deceleration time IV refers to jog acceleration/deceleration time.

Relevant parameters: F044-F049, F084, F085 .

| F022                             | Setting range  | Unit | Ex-factory value | Alteration |
|----------------------------------|--|------|------------------|------------|
| Emergency stop deceleration time | 0.1~6500.0s<br>0.0 refer to emergency stop set by coasting to stop | 0.1s | 0.0              | ○          |

VFD deceleration stop is set by emergency stop deceleration time during emergency stop.if emergency stop deceleration time is 0.0, it means emergency stop is set by coasting to stop. Emergency stop command can be get from digital input terminal 13 function(emergency stop).

## 6.2 Application function parameters

| F023             | Setting range | Unit | Ex-factory value | Alteration |
|------------------|---------------|------|------------------|------------|
| Reverse prohibit | 0~1           | 1    | 1                | ×          |

0: Reverse prohibit      1: Reverse valid

This parameter setting is applied to sites where motor is irreversible so as to avoid misoperation of operators. When reverse is prohibited, motor can only rotate in a forward way rather than in a reverse way.

| F024                     | Setting range | Unit | Ex-factory value | Alteration |
|--------------------------|---------------|------|------------------|------------|
| Stop key is valid or not | 0~1           | 1    | 1                | ×          |

0: STOP key is invalid    1: STOP key is valid

When control mode refers to external terminal control or communication control, the stop key on the panel can select whether to be valid. If selecting valid, the panel will stop the VFD. If it is necessary to restart, remove the running signal firstly and then restart the VFD

This parameter is only valid when F001 is set as 1 or 2.

| F025          | Setting range | Unit | Ex-factory value | Alteration |
|---------------|---------------|------|------------------|------------|
| Start up mode | 0~1           | 1    | 0                | ×          |

Two kinds of start up modes can be set as required by different equipment.

0: Start from start up frequency. When F029 is set as zero, the DC braking at the time of start up is invalid and the start up shall be conducted from start-up frequency. When F029 is not zero, the DC braking at the time of start up is valid; when starting, firstly start the DC braking and then start from start-up frequency (F027) .

1: Frequency tracking startup: this parameter can be used to restart of high-inertia load. When restarting, the frequency set by VFD will make frequency tracking downward. When restarting, operating command can be executed without fully stopping of equipment and tracking startup also can be made to save time if there is high-inertia load equipment. Refer to figure 6-3 as detailed.

Refer to P027,P029 and 031P for relevant parameters.

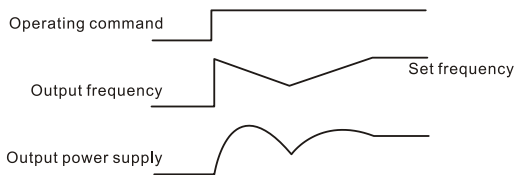

Figure 6-3 Frequency Tracking Startup

[Note] During frequency tracking startup, the frequency set by VFD will make frequency tracking downward and carry out tracking at the maximum speed. During starting, the current may be relatively large and overcurrent or stalling phenomenon may occur. It is necessary to pay attention to the adjustment of tracking current level. F033 is generally set at about 100 and shall be specifically set as per the mechanical inertia.

| F026 | Setting range | Unit | Ex-factory value | Alteration |
|------|---------------|------|------------------|------------|
|------|---------------|------|------------------|------------|



|           |     |   |   |   |
|-----------|-----|---|---|---|
| Stop mode | 0~1 | 1 | 0 | × |
|-----------|-----|---|---|---|

0: For deceleration stop, when F030 is 0, DC braking is invalid. When DC braking is invalid, the VFD will decelerate to stop frequency and stop output, and motor will stop in self-running manner. When F030 is not 0, DC braking is valid, after VFD decelerates to stop frequency, it will stop in DC braking manner. When stopping, DC braking is usually used for high-position stop or positioning control. Note: frequently using DC braking may cause overheat of motor. Relevant parameters are F028, F030 and F031.

1: After free running stop VFD receives stop command, VFD will immediately stop output and motor will stop in free running manner. Under such manner, DC braking is invalid.

| F027              | Setting range | Unit  | Ex-factory value | Alteration |
|-------------------|---------------|-------|------------------|------------|
| Startup frequency | 0.1~30.0 Hz   | 0.1Hz | 0.5              | ×          |

Startup frequency refers to initial starting frequency of VFD, for instance, when the startup frequency is set as 5.0 Hz, VFD will run between 5.0Hz to maximum operation frequency after it is started at 5.0Hz.

Relevant parameters: F025, F029 and F031.

| F028           | Setting range | Unit  | Ex-factory value | Alteration |
|----------------|---------------|-------|------------------|------------|
| Stop frequency | 0.1~30.0 Hz   | 0.1Hz | 0.5              | ×          |

When VFD is under deceleration stop and frequency decreases to stop frequency, the VFD will stop output or start DC braking stop.

When F030 is 0, the DC braking when stopping is invalid and VFD will stop output when it decreases to F028. When F030 is set as valid, VFD will stop in DC braking manner when it decreases to F028.

Relevant parameters: F028, F030 and F031.

| F029                 | Setting range | Unit | Ex-factory value | Alteration |
|----------------------|---------------|------|------------------|------------|
| DC braking time when | 0.0~25.0s     | 0.1s | 0.0              | ×          |

This parameter will enter DC braking status when it is set as startup and will be input into duration time of motor DC braking current. When it is set as zero, it means the DC braking is invalid. Refer to Figure 6-4 for details.

DC braking start up is usually used when load can move under fan stop status for motor will be in free running status with uncertain direction before VFD outputs voltage. Therefore, we can execute DC braking before startup and then start the motor to avoid the tripping of motor.

Parameters will be valid when F025 is set as zero. Refer to F028, F029 and F031 for relevant parameters.

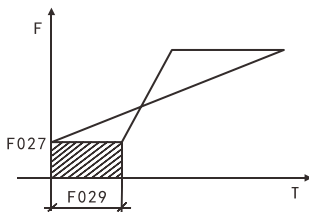

Figure 6-4 DC Braking Time when Starting

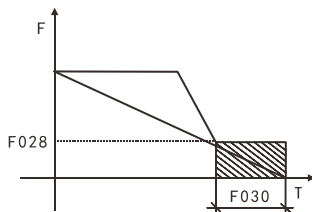

Figure 6-5 DC Braking Time when Stopping

| F030                          | Setting range | Unit | Ex-factory value | Alteration |
|-------------------------------|---------------|------|------------------|------------|
| DC braking time when stopping | 0.0~25.0s     | 0.1s | 0.0              | ×          |

When this parameter is set as non-zero, the DC braking when stopping is valid and it will enter the motor DC braking time. When stopping, DC braking is usually used for high-position stop or positioning control. When this parameter is zero, DC braking is invalid. Refer to Figure 6-5 for details.

This parameter is valid when F026 is set as zero. Refer to F026, F028 and F031 for related descriptions.

| F031             | Setting range | Unit | Ex-factory value | Alteration |
|------------------|---------------|------|------------------|------------|
| DC braking level | 0.0~20.0%     | 0.1% | 2.0              | ×          |

This parameter can be used to set the input motor DC braking voltage when starting and stopping and adjusted to obtain different braking voltages. The parameter must be adjusted from small to large slowly until sufficient braking torque is reached, otherwise the motor will be damaged.

100% voltage shall be used for maximum operation frequency.

| F032                    | Setting range | Unit | Ex-factory value | Alteration |
|-------------------------|---------------|------|------------------|------------|
| Frequency tracking time | 0.1~20.0s     | 0.1s | 5.0              | ×          |

In case of external exception or temporary power failure, this parameter will be set as frequency tracking time when VFD is executing frequency tracking. In some large inertia load starting and stopping, restarting after machinery fully stops will waste much time for load inertia is large. After frequency tracking is enabled, the starting can be executed without complete stop of machinery. And VFD will conduct frequency tracking from top to down with set frequency and then continue to accelerate to set frequency after tracking.

| F033                             | Setting | Unit | Ex-factory value | Alteration |
|----------------------------------|---------|------|------------------|------------|
| Frequency tracking current level | 0~200%  | 1%   | 150              | ×          |

When VFD is executing frequency tracking, output current shall take this set value as level. When output current is larger than this level, the frequency will drop and make current below current level, and then re-execute the frequency tracking.

| F034  | Setting range | Unit | Ex-factory value | Alteration |
|---|---------------|------|------------------|------------|
| Voltage rising time during frequency tracking | 0.1~10.0s     | 0.1s | 0.5              | ○          |

When startup mode of VFD is set as frequency tracking, there is a voltage rising process. When the voltage rising is too fast, the current will be very large and the tracking process will be fast. If the voltage rising is slow, the current will be small and tracking will also be slow. The general setting mode is that for machinery with small power, F034 shall be set as a small value while for machinery with large power.

| F035– F040 | reserve |
|------------|---------|
|            |         |

| F041              | Setting range | Unit | Ex-factory value | Alteration |
|-------------------|---------------|------|------------------|------------|
| Carrier frequency | 0~15          | 1    | *                | ×          |

Carrier frequency is related to electromagnetic noise of motor as well as to VFD's heat productivity and disturbance to environment. Refer to the following table:

| Carrier frequency | Electromagnetic noise | Heat productivity | Disturbance to environment |
|-------------------|-----------------------|-------------------|----------------------------|
| Small<br>↓        | Large<br>↓            | Small<br>↓        | Small<br>↓                 |
| Large             | Small                 | Large             | Large                      |

Carrier Mapping Table:

| Setting value         | 0    | 1 | 2 | 3 | 4 | 5 | 6 | 7 | 8 | 9  | 10 | 11 | 12 | 13 | 14 | 15 |
|-----------------------|------|---|---|---|---|---|---|---|---|----|----|----|----|----|----|----|
| Carrier frequency KHz | 1.25 | 2 | 3 | 4 | 5 | 6 | 7 | 8 | 9 | 10 | 11 | 12 | 13 | 14 | 15 | 16 |

The higher the carrier frequency is, the smaller the motor's electromagnetic noise will be, but the disturbance to other systems will be stronger and the heat productivity of VFD will be larger. When the ambient temperature is relatively high and the motor load is relatively heavy, we can appropriately reduce the carrier frequency to improve the heat characteristics of VFD.

The ex-factory value of carrier frequency is set as per model.

| F042          | Setting range | Unit  | Ex-factory value | Alteratio |
|---------------|---------------|-------|------------------|-----------|
| Jog frequency | 0.0~1000.0Hz  | 0.1Hz | 5.00             | ○         |

This parameter can realize the jog function in machine testing and jog operation only can be realized through 6-way programmable terminals. Jog frequency is limited by maximum operation frequency and lower frequency limit. When the jog function is enabled, other operating command will not be accepted and the acceleration time of jog frequency is determined by acceleration time IV. After the jog button is released, VFD will immediately stop output. When realizing the jog function, please set any one of corresponding 6-way programmable terminals as 07 or 08.

Jog function is only valid under shutdown status but invalid during running.

Refer to F044-F049 for relevant parameters.

| F043         | Setting range | Unit | Ex-factory value | Alteration |
|--------------|---------------|------|------------------|------------|
| S curve time | 0.0~6500.0s   | 0.1s | 0.0              | ○          |

This parameter is used to set the soft start or soft stop without impact during start or stop of VFD; when S curve is started, the VFD will make the acceleration/deceleration curves with different speed as per the acceleration/deceleration time. Refer to Figure 6-6 for S curve time description.

When F043 is set as zero, S curve is invalid, i.e it will accelerate and decelerate in a straight line, irrespective of stalling situation, this parameter will be valid when F014 is smaller than F043 provided that the actual acceleration is  $(F014+F043)/2$ .

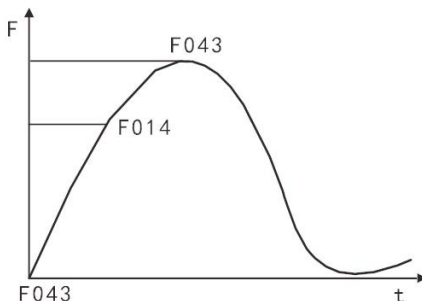

Figure 6-6 S Curve Time

### 6.3 Functional parameter of input/output terminals

| F044 | Setting range | Unit | Ex-factory value | Alteration |
|------|---------------|------|------------------|------------|
|------|---------------|------|------------------|------------|

|                      |       |   |      |   |    |
|----------------------|-------|---|------|---|----|
| X1 terminal function | 00~32 | 1 | 02   | x |    |
| F045                 |       |   | 03   |   |    |
| X2 terminal function |       |   | 14   |   |    |
| F046                 |       |   | 22   |   |    |
| X3 terminal function |       |   | F047 |   | 23 |
| F047                 |       |   | 24   |   |    |
| X4 terminal function |       |   | F048 |   |    |
| F048                 |       |   |      |   |    |
| X5 terminal function |       |   | F049 |   |    |
| F049                 |       |   |      |   |    |
| X6 terminal function |       |   |      |   |    |

01: RUN (running, & can form several control mode in combination with other terminals.)

02: FOR (forward rotating)

03: REV (reverse rotating)

04: STOP (stopping)

05: FOR/REV (forward/reverse switching, which may also be enabled through three-wire connection. Refer to the following text for details.)

06: JOG (jog)

07: Jog forward, with related parameters of F020, F021, F042.

08: Jog reverse, with related parameters of F020, F021, F042.

09: External control timer 1 start

10: External control timer 2 start

Upon contact closure, the timer is started to time. When time is over, multi-functional output point will be actuated.

11: Set forced frequency switching as F003.

12: In case radiator or motor is overheating, this contact shall be used for detection to protect motor and VFD.

13: Emergency cut-off may receive external fault signals such as emergency stop.

14: Reset can be used after fault elimination.

15~16: Reserve

17: Acceleration/deceleration time selection I

18: Acceleration/deceleration time selection II

Four selections of acceleration/deceleration time for VFD are given here.

19: Multi-segment speed I

20: Multi-segment speed II

21: Multi-segment speed III (16-segment speed can be set with multi-segment speed I, II, III and IV.)

22: High speed

23: Medium speed

24: Low speed

Combination of high, medium and low speed can enable three running modes with different frequency, wherein high-end signal prevails. Three kinds of speed are respectively determined by frequency II, III and IV.

25: PID is allowed to close; PID function is enabled and is allowed to be only effective during running.

26: Multi-segment speed IV

27: UP function

28: DOWN function

Upon actuation of this terminal, VFD frequency will increase or decrease for one unit. When switch is retained, frequency will uniformly change after rapidly increasing or decreasing to some extent. Altered frequency can be memorized or not based on parameter selection in case of power failure and recover.

29: Draft allowance (Draft actuation is allowed upon triggering of this contact.)

31: Pulse counter (This terminal can receive pulse signals not more than 250Hz and make counting after being set as counter.)

32: Counter reset (Actuation of this contact will make current count value eliminated, with "C00" showed and recounting conducted.)

#### ◆ Three-wire connection

Three multi-functional terminals shall be used for three-wire connection to enable switching between forward and reverse rotating, which is widely used for optoelectronic switch and other cases, as shown in Figure 6-7.

##### (1) Button description

B1: Forward Button (normally open), with effective edge

B2: Reverse Button (normally open), with effective edge

B3: Stop Button (normally closed), with effective edge

(2) Parameter set

F001=1 under external terminal control

F044=02 X1 is set as forward function

F045=03 X2 is set as reverse function

F046=04 X3 is set as stop function

(3) Actuation description

Triggering of X1 enables VFD forward (start);

Triggering of X2 enables VFD reverse;

Disconnection of normally closed button B3 enables VFD stop.

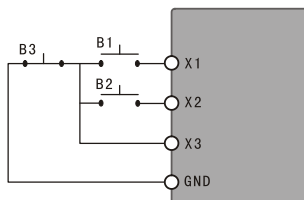

Figure 6-7 Three-wire Wiring Diagram

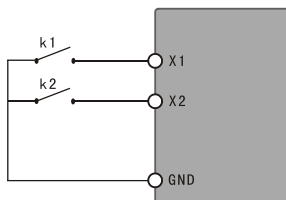

Figure 6-8 Two-wire Wiring Diagram

#### ◆ Two-wire connection

Enable start, stop, forward/reverse switching, as shown in Figure 6-8. K1, K2 refer to effective level.

(1) Parameter set: F001=1(external terminal control), F044=01(X1 is set as RUN function), F045=05(X2 is set as FOR/REV switching function). Upon closing of K1, VFD runs in a free way. VFD runs in a forward way when K2 is disconnected and in a reversed way when K2 is closed.

(2) Parameter set: F001=1(external terminal control), F044=02(X2 is set as forward function), F045=03(X2 is set as reverse function). Upon closing of K1, VFD runs in a forward way and runs in a reverse way when K2 is closed.

#### ◆ Acceleration/deceleration time selection I & II

| X4 terminal | X5 terminal | Result                             |
|-------------|-------------|------------------------------------|
| OFF         | OFF         | Acceleration/deceleration time I   |
| ON          | OFF         | Acceleration/deceleration time II  |
| OFF         | ON          | Acceleration/deceleration time III |
| ON          | ON          | Acceleration/deceleration time IV  |

[Description] 1) This function is enabled when F080 is set as 0, 2 and 3 and disabled upon disturbed and internally controlled multi-segment speed;

2) Four selections of acceleration/deceleration are available with combination of any two

multi-function input terminals;

3) Related multi-function input terminals are set as acceleration/deceleration time selection I and II. Take terminals X4 and X5 for example. If F047 of terminal X4 is set as 17 and F048 of terminal X5 is set as 18, then acceleration/deceleration time selection I and II are enabled for terminals X4 and X5 respectively.

#### ◆ Function of high, medium and low speed terminals

| RUN | X6     | X5     | X4  | Result  |
|-----|--------|--------|-----|---|
| ON  | OFF    | OFF    | OFF | Main speed, with set value of F003 as the frequency |
| ON  | ON     | OFF    | OFF | Low speed, with set value of F086 as the frequency  |
| ON  | ON/OFF | ON     | OFF | Medium speed, with set value of F087 as the         |
| ON  | ON/OFF | ON/OFF | ON  | High speed, with set value of F088 as the frequency |

[Description] 1) This function is only enabled when F080 is set as 2, i.e. externally controlled 4-segment speed is effective;

2) Acceleration/deceleration time is determined through acceleration/deceleration selection terminal;

3) In case of simultaneous signals from high, medium and low speed, priority shall be given as per the sequence of high, medium and low speed.

#### ◆ UP and DOWN functions

| UP  | DOWN | Result                     |
|-----|------|----------------------------|
| ON  | OFF  | Frequency up               |
| OFF | ON   | Frequency down             |
| ON  | ON   | Frequency remains the same |

[Description] 1) UP and DOWN functions are only enabled when the frequency source is under keyboard operation, i.e. P002 is 0.

2) UP and DOWN functions are effective during running and the frequency cannot be changed during standby.

3) Operating frequency will not rise when it reaches the maximum.

4) Operating frequency will not decrease when it reaches the minimum or lower limit.

5) When UP and DOWN functions are adopted, up and down speed shall be dependent on current acceleration/deceleration time.

6) If UP or DOWN is long pressed, the frequency will rapidly increase or decrease to some extent and then increase or decrease uniformly.

7) The value modified through UP or DOWN through setting of F077 and F117, make sure stop memory or power fault memory function.

#### ◆ Description of counter function



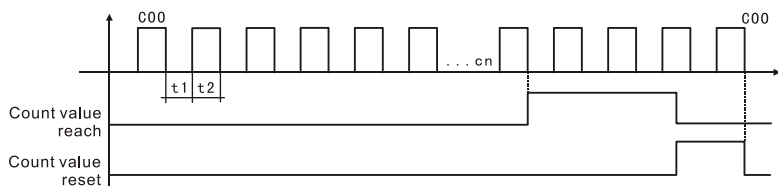

Figure 6-9 Description Diagram of Counter Function

- [Description] 1) Trigger signal duration shall not be lower than 2ms ( $t_1, t_2 \geq 2\text{ms}$ )  
 2) Count value reach is corresponding to actuation of multifunctional output contact.  
 3) Recounting may be conducted only after the counter is reset;  
 4) The counter will stop counting upon 65535.

| F050                                     | Setting range | Unit | Ex-factory value | Alteration |
|--|---------------|------|------------------|------------|
| Y1 output function                       | 00~32         | 1    | 01               | ○          |
| F051                                     |               |      | 05               |            |
| Y2 output function                       |               |      | 00               |            |
| F052                                     |               |      | 03               |            |
| Output function of terminals KA &        |               |      |                  |            |
| F053                                     |               |      |                  |            |
| Output function of terminals FA, FB & FC |               |      |                  |            |

- 01: Indications during running Contact is enabled in case of output or running indication from VFD.
- 02: Zero-speed indication Contact is enabled if output frequency is less than start-up frequency.
- 03: Fault indication Contact is enabled in case VFD is abnormal.
- 04: DC braking indication Contact is enabled if VFD is under DC braking condition.
- 05: Set frequency reaching indication Contact is enabled if output frequency reaches set frequency.
- 06: Underway acceleration indication Contact is enabled if VFD is under accelerating condition.
- 07: Underway deceleration indication Contact is enabled if VFD is under decelerating condition.
- 08: Frequency consistency I arrival indication Contact is enabled if output frequency reaches designated frequency (F60).
- 09: Frequency consistency II arrival indication Contact is enabled if output frequency reaches designated frequency (F61).
- 10: Motor overload warning indication Contact is enabled if motor overload is detected by the VFD.

|   |   |
|---|---|
| 11: Torque rich detection indication  | Contact is enabled if torque rich is detected by the VFD.   |
| 12: VFD overload warning indication   | Contact is enabled if overload is detected by the VFD.  |
| 13: Pulse set counter reaching indication                                       | Contact is enabled if count value reaches set value (F065) when external counter is executed.   |
| 14: Pulse medium counter reaching indication                                    | Contact is enabled if count value reaches set value (F066) when external counter is executed.   |
| 15: External control timer I reaching indication                                | Contact is enabled if timer I reaches set value.  |
| 16: External control timer II reaching indication                               | Contact is enabled if timer II reaches set value.   |
| 17: Low voltage warning indication  | Contact is enabled if low voltage is detected by the VFD.   |
| 18: Stage completion indication for internally controlled multi-segment speed   | Contact is enabled and one pulse is output after each stage is completed under programming operation of the VFD.                          |
| 19: Process completion indication for internally controlled multi-segment speed | Contact is enabled and one pulse is output after all stages are completed (i.e. after one circle) under programming operation of the VFD. |
| 20: 4-20mA disconnection indication   | Contact is enabled if AI input signal is disconnected and F070 is more than 2.  |
| 21-24: Reserve  |   |
| 25: Actuation indication of auxiliary pump 1                                    | Contact controls start-up and stop of the auxiliary pump. Refer to description of multi-pump operation for details.                       |
| 26: Actuation indication of auxiliary pump 2                                    |   |
| 27: Draft completion indication   | Contact is enabled when draft is completed and it will automatically reset when the VFD stops.  |
| 28: PID lower limit warning indication  | Contact is enabled if PID feedback quantity is less than the lower limit (F162).  |
| 29: PID upper limit warning indication  | Contact is enabled if PID feedback quantity is more than the upper limit (F161).  |
| 30: Braking resistor actuation indication                                       | Contact is enabled if the VFD is under operation and DC voltage is higher than braking voltage.   |
| 31: Electromagnetic relay actuation indication                                  | Corresponding contact is enabled when contactor pulls in.   |
| 32: Fan actuation indication  | Corresponding contact is enabled when the VFD temperature rises or the VFD is running.  |

| F054               | Setting range | Unit | Ex-factory value | Alteration |
|--------------------|---------------|------|------------------|------------|
| A0 output function | 0~3           | 1    | 0                | ○          |

Digit frequency output terminal outputs pulse quantity or 0-10V analog quantity. In combination with F055, it can be used for external monitoring after being connected to

corresponding instruments with range under 10V.

0: 0-10V analog quantity output, corresponding to output frequency, 0-10V corresponding to 0-maximum operation frequency

1: 0-10V analog quantity output, corresponding to output current, 0-10V corresponding to 0-two times of rated current of the VFD

2: Analog quantity output, corresponding to DC bus voltage, 0-10V corresponding to 0-1000V

3: Analog quantity output, corresponding to output AC voltage, 0-10V corresponding to 0-510V/255V

| F055              | Setting range | Unit | Ex-factory value | Alteration |
|-------------------|---------------|------|------------------|------------|
| A0 analogy output | 0~100%        | 1%   | 100              | ○          |

This parameter can be used to adjust output voltage of analog terminal so as to adapt to frequency instrument with different range and to calibrate the instruments. It can also be used for calibration if a revolution meter with a range of 0-5V is connected to display operating frequency through multi-functional terminals, with F055 set as 50.

| F056                    | Setting range | Unit  | Ex-factory value | Alteration |
|-------------------------|---------------|-------|------------------|------------|
| Hopping frequency 1     | 0.0~1000.0 Hz | 0.1Hz | 0.0              | ○          |
| F057                    |               |       |                  |            |
| Hopping frequency 2     |               |       |                  |            |
| F058                    | 0.10~10.00 Hz | 0.1Hz | 0.5              | ○          |
| Hopping frequency 3     |               |       |                  |            |
| F059                    |               |       |                  |            |
| Hopping frequency range |               |       |                  |            |

To avoid mechanical resonance point, these three frequency hopping points are set. The actual hopping frequency range is two times that of F059 and all hopping frequency will be invalid when F059=0, as shown in Figure 6-10.

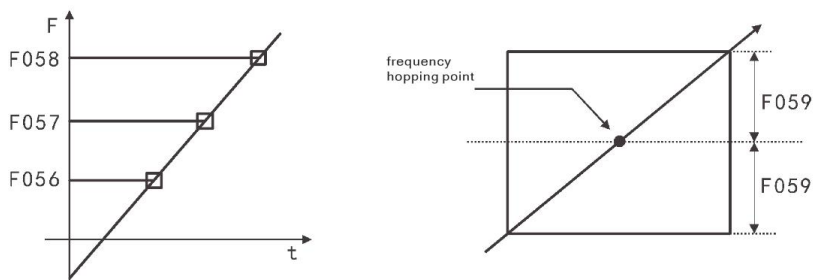

Figure 6-10 Frequency Hopping

| F060  | Setting range | Unit    | Ex-factory value | Alteration |
|---|---------------|---------|------------------|------------|
| Frequency consistency I<br>(constant pressure water supply high speed frequency)        | 0.0~1000.0 Hz | 0.01 Hz | 0.0              | ○          |
| F061<br>Frequency consistency II(constant pressure water supply lower speed frequency)) |               |         |                  |            |
| F062<br>Frequency consistency range   | 0.1~10.0 Hz   | 0.1 Hz  | 0.5              |            |

When output frequency is more than consistent frequency, corresponding multi-functional output terminal is enabled, with consistent frequency range as a hysteresis loop. When the VFD is used for constant-pressure water supply, F060 is used as high-speed frequency and F061 is set as low-speed frequency.

| F063  | Setting range | Unit | Ex-factory value | Alteration |
|---|---------------|------|------------------|------------|
| Time set of external control timer I          | 0.1~10.0s     | 0.1s | 0.1              | ×          |
| F064<br>Time set of external control timer II | 1~100s        | 1s   | 1                | ×          |

External control timer I is a timer of 0.1S-10.0s and external control timer II is of 1s-100s. When multi-functional input terminal timer opens or closes, the timer starts to time; when the timer reaches, corresponding multi-functional output contact is enabled; when the timer disconnects, multi-functional output terminal timer resets. During operation, the timer will continue timing normally in spite of stop due to fault and will reset automatically in case of stop due to power failure.

| F065                             | Setting range | Unit | Ex-factory value | Alteration |
|----------------------------------|---------------|------|------------------|------------|
| Pulse count value set            | 0~65500       | 1    | 0                | ○          |
| F066<br>Pulse medium counter set | 0~65500       | 1    | 0                | ○          |

6-way multi-function input terminals can be used as trigger terminal of the counter. When count value reaches the set value F065, corresponding multi-function output contact is enabled. After zero clearing, the counter resets to enable recounting. Proximity switch and optoelectronic switch can be used for trigger signal.

| F067  | Setting range | Unit | Ex-factory value | Alteration |
|---|---------------|------|------------------|------------|
| Positive and negative logic of digital input terminal | 0~1           | 1    | 0                | ×          |

0: Positive logic, with NPN as wiring mode      1: Negative logic, with PNP as wiring mode

It shall be used together with Jumper J2. In case of NPN as the external wiring mode, J2 jumps to NPN, with F067 set as 0; in case of PNP as the external wiring mode, J2 jumps to PNP, with F067 set as 1.

| F068                                     | Setting range | Unit | Ex-factory value | Alteration |
|--|---------------|------|------------------|------------|
| Digital input dithering elimination time | 0~60000ms     | 1    | 20               | ○          |

| F069                           | Setting range | Unit | Ex-factory value | Alteration |
|--------------------------------|---------------|------|------------------|------------|
| Pulse output maximum frequency | 1.0~10.0kHz   | 0.1  | 10.0             | ×          |

## 6.4 Functional parameter of analog quantity

| F070  | Setting range | Unit | Ex-factory value | Alteration |
|---|---------------|------|------------------|------------|
| Input channel selection for analog quantity | 0~11          | 1    | 0                | ×          |

There are two channels AI1 and AI2 and three modes to be selected for analog quantity input:

The unit :    0: 0~10V      1: 0~5V

decade :    0: 0~20mA / 0~10V    1: 4~20mA/2~10V

[Note] Current or voltage input can be selected by channel 2 through jumper J3

This parameter can be set to satisfy different analog input signals.

| F071                              | Setting range | Unit | Ex-factory value | Alteration |
|-----------------------------------|---------------|------|------------------|------------|
| Filtering time of analog quantity | 0~1000ms      | 1    | 20               | ×          |

Setting of this parameter is related to reaction speed of analog quantity; the larger the F071 is set, the slower the analog quantity makes response.

| F072 | Setting range | Unit | Ex-factory value | Alteration |
|------|---------------|------|------------------|------------|
|------|---------------|------|------------------|------------|

|                                       |               |        |      |   |
|---------------------------------------|---------------|--------|------|---|
| High-end frequency of analog quantity | 0.0~1000.0 Hz | 0.1 Hz | 50.0 | × |
| <b>F073</b>                           |               |        |      | × |
| Low-end frequency of analog quantity  | 0.0~1000.0 Hz | 0.1 Hz | 0.0  |   |
| <b>F074</b>                           |               |        |      | × |
| Bias direction of high-end frequency  | 0~1           | 1      | 0    |   |
| <b>F075</b>                           |               |        |      | × |
| Bias direction of low-end frequency   | 0~1           | 1      | 0    |   |

0: Positive direction 1: Negative direction

Bias direction refers to forward/reverse command instruction; positive bias represents forward and negative bias symbolizes reverse. Refer to diagram description of F076 for details.

|  |               |      |                  |            |
|--|---------------|------|------------------|------------|
| <b>F076</b>  | Setting range | Unit | Ex-factory value | Alteration |
| Reverse selection for negative bias of analog quantity | 0~1           | 1    | 0                | ×          |

0: Reverse unavailable for negative bias 1: Reverse available for negative bias

This parameter can be used to set range and zero point of external analog terminal, thus composing any form of curve to control the motor, as shown in Figure 6-11.

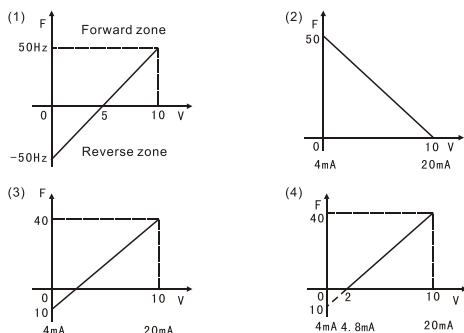

Figure 6-11 Setting Curve for Analog Quantity

(1) Parameters: F073=50 F075=1 F072=50 F074=0 F076=1

[Description] The curve can be used to make easy combination with other systems for various complex applications. When the curve is applied, forward/reverse instruction of external terminals is still effective, meaning the curve will be reversed upon forward/reverse switching.

(2) Parameters: F073=50 F075=0 F072=0 F074=0 F076=0

[Description] The curve is specially applied to negative slope setting, where pressure and temperature are controlled by transducer, with a large quantity of pressure and output signals. Therefore, the curve exactly meets requirements when stop or deceleration is required of corresponding VFD.

(3) Parameters: F073=10 F075=1 F072=40 F074=0 F076=1

[Description] It can be widely and flexibly used by users.

(4) Parameters: F073=10 F075=1 F072=40 F074=0 F076=0

[Description] This curve is an extended one of the above curve. 2V-10V (4.8mA-20mA) is corresponding to 0Hz-40Hz and signals of 0V-2V (4-4.8mA) are invalid. The curve can be used to avoid noise disturbance. Under severe environment, signals under 1V shall not be used as far as possible to set operating frequency of the VFD.

| F077                                    | Setting range | Unit | Ex-factory value | Alteration |
|---|---------------|------|------------------|------------|
| Memory function selection for UP & DOWN | 0~1           | 1    | 0                | ×          |

0: Not memorized      1: Memorized

This parameter can be used to select whether the value modified through UP and DOWN is memorized or not after stop. When F077 is set as 1, the value upon stop will be memorized after re-start up; if need power off protection, then set F117 to 1 with the value of UP and DOWN at the same time.

Refer to F044-F049 description for details about related parameters.

| F078                              | Setting range | Unit | Ex-factory value | Alteration |
|-----------------------------------|---------------|------|------------------|------------|
| Increment selection For UP & DOWN | 0~1           | 1    | 0                | ×          |

0: For 0.01HZ, minimum up/down speed is 0.01HZ

1: For 0.1HZ, minimum up/down speed is 0.1HZ

This parameter can be used to adjust up/down speed unit for UP and DOWN to meet users' need.

| F079                             | Setting range | Unit | Ex-factory value | Alteration |
|----------------------------------|---------------|------|------------------|------------|
| Increment multiple for UP & DOWN | 1~250         | 1    | 0                | ×          |

The actual increment of UP and DOWN refers to the result after values of F078 and F079 are multiplied.

## 6.5 Functional parameters of multi-segment speed

| F080                               | Setting range | Unit | Ex-factory value | Alteration |
|------------------------------------|---------------|------|------------------|------------|
| Multi-segment speed mode selection | 0~5           | 1    | 2                | ×          |

0: Normal operation

1: Internally controlled 16-segment speed

2: Externally controlled 4 segment speed

3: Externally controlled 16-segment speed

4: Externally controlled 4 segment speed(running command valid automatically)

5: Externally controlled 16-segment speed(running command valid automatically)

1: Internally controlled multi-segment( 16-segment speed)

[Description]

1) 16-segment speed is composed by main speed and 15-segment speed;  
 2) Acceleration/deceleration time of each segment speed is set through F084 and F085;  
 3) Operating time is set by timers F101-F116 and timers for unused control segments are set as 0;  
 4) Operating direction of each segment speed is set through F082 and F083;  
 5) Under operation of internally controlled multi-segment speed, operating time and direction is dependent on the setting of internal parameters, with invalid external time and forward/reverse switching.

2: Externally controlled 4-segment speed (refer to function description for high-speed, medium-speed and low-speed terminals F044-F049)

3: Externally controlled 16-segment speed

| Multi-function digital input terminal |                        |                         |                        | Result         |
|---------------------------------------|------------------------|-------------------------|------------------------|----------------|
| Multi-segment speed I                 | Multi-segment speed II | Multi-segment speed III | Multi-segment speed IV |                |
| OFF                                   | OFF                    | OFF                     | OFF                    | Main frequency |



|     |     |     |     |   |
|-----|-----|-----|-----|---|
| ON  | OFF | OFF | OFF | For multi-segment speed II, the frequency is determined by F086   |
| OFF | ON  | OFF | OFF | For multi-segment speed III, the frequency is determined by F087  |
| ON  | ON  | OFF | OFF | For multi-segment speed IV, the frequency is determined by F088   |
| OFF | OFF | ON  | OFF | For multi-segment speed V, the frequency is determined by F089    |
| ON  | OFF | ON  | OFF | For multi-segment speed VI, the frequency is determined by F090   |
| OFF | ON  | ON  | OFF | For multi-segment speed VII, the frequency is determined by F091  |
| ON  | ON  | ON  | OFF | For multi-segment speed VIII, the frequency is determined by F092 |
| OFF | OFF | OFF | ON  | For multi-segment speed IX, the frequency is determined by F093   |
| ON  | OFF | OFF | ON  | For multi-segment speed X, the frequency is determined by F094    |
| OFF | ON  | OFF | ON  | For multi-segment speed XI, the frequency is determined by F095   |
| ON  | ON  | OFF | ON  | For multi-segment speed XII, the frequency is determined by F096  |
| OFF | OFF | ON  | ON  | For multi-segment speed XIII, the frequency is determined by F097 |
| ON  | OFF | ON  | ON  | For multi-segment speed XIV, the frequency is determined by F098  |
| OFF | ON  | ON  | ON  | For multi-segment speed XV, the frequency is determined by F099   |
| ON  | ON  | ON  | ON  | For multi-segment speed XVI, the frequency is determined by F100  |

## [Description]

- 1) When F080 is set as 3, externally controlled multi-segment speed mode is effective;
- 2) Any four digital input terminals are selected, with their functions set as 19 multi-segment speed I, 20 multi-segment speed II, 21 multi-segment speed III and 26 multi-segment speed IV respectively;
- 3) Multi-segment speed I, II, III and IV can be used to form 15-segment speed; 16-segment speed will be available when main frequency is involved;
- 4) Each acceleration/deceleration time and programming operation direction is determined by external terminals
- 5) Main frequency is set by F002; when F002=0, i.e. main frequency is set by keyboard, main frequency is value of F003.

4: Draft is a special parameter used to realize a constant speed for taking up and paying off of curl cord, i.e. constant linear speed can be realized within certain accuracy, as shown in

Figure 6-12.

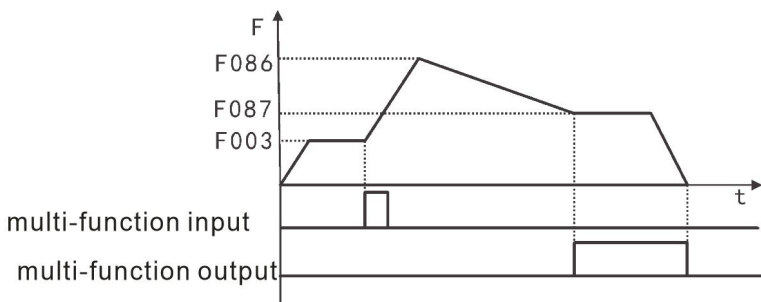

Figure 6-12 Draft Actuation Curve

## [Description]

- 1) Draft will be actuated upon triggering of the external multi-function terminal.
- 2) During draft actuation, running time T is  $F101 \times 10$ .
- 3) After the completion of draft actuation, the VFD outputs at a constant speed (F087), and corresponding multi-function output contacts are actuated until the stop command is issued, and then, the VFD stops running, and multi-function output contact resets.

5: Disturbance (traverse function) This parameter is specific for the chemical fiber, printing and dyeing; any command input, except stop, external fault, and emergency stop in the running, is not accepted.

## [Description] 1) Each frequency of the turning point is determined by F003 and F086;

- 2) The hopping frequency is determined by F092;
- 3) The running time is determined by F101 and F102;
- 4) Related parameters: F003 and F086-F116.

| F081  | Setting Range | Unit | Ex-factory value | Alteration |
|---|---------------|------|------------------|------------|
| Running mode selection of internally controlled multi-segment speed | 0~3           | 1    | 0                | ×          |

0: Program running stops after one cycle

- 1: Circular running
- 2: Automatic running (stop interval) stops after one cycle
- 3: Automatic running (stop interval) in circular running.

This parameter setting is only effective when F080 is set as 1. Refer to F003, F080, and F082-F116 for related parameters.

## [Description]

- 1) Program running stops after one cycle: the VFD runs at the set value of internal parameters after the command of automatic program running is given, and stops automatically after running for one cycle. The VFD can restart after the second running command is given.
- 2) Circular running: the VFD runs in sequence and circularly at the set value of internal parameters for segment speed frequency and running time; any command input, except stop, external fault, and emergency stop in the circular running, is not accepted.
- 3) Automatic running (stop interval) stops after one cycle.

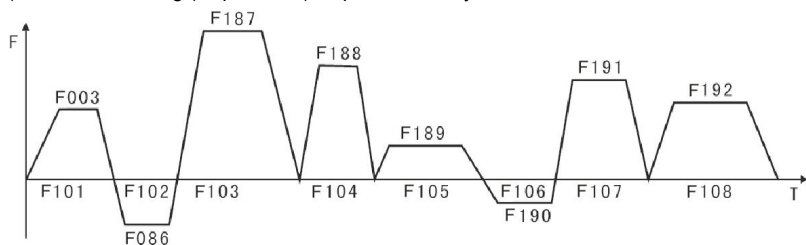

Figure 6-13 Running Curve and Control Parameters for Internally Controlled Multi-segment Speed

- [Description]
- 1) The VFD runs according to parameters after the command of automatic programming running is given, but stop first and then restart in the transformation of each stage; stop automatically after running for one cycle, and the VFD restarts after the second running command is given;
  - 2) The frequency for each segment speed is set by F003, F086 ~ F100;
  - 3) The running time for each segment speed is set by F101 ~ F116;
  - 4) The running direction is set by F082, F083.

| F082  | Setting Range | Unit | Ex-factory value | Alteration |
|---|---------------|------|------------------|------------|
| Speed running direction of first 8 segments | 0~255         | 1    | 0                | ×          |
| F083  |               |      | 0                | ×          |
| Speed running direction of last 8 segments  |               |      |                  |            |

F082 parameter set is only effective when F080 is set as 1, The setting mode of running direction for frequency band of F086-F092 and F003 in the programming running is as follows:

The running direction is set by binary 8bit which can be changed into decimal value for the parameter setting. For example, parameter value 01001010 can be changed into decimal

value, i.e.,  $1 \times 2^6 + 1 \times 2^3 + 1 \times 2^1 = 64 + 8 + 2 = 74$ , P082=74. F082=74. F083 is set for the speed running direction of last 8 segments (calculation method is as the same as that for F082).

| F084  | Setting Range | Unit | Ex-factory value | Alteration   |
|---|---------------|------|------------------|--|
| Acceleration/deceleration time selection for first 8 segments | 0~65535       | 1s   | 0                | ×  |
| F085  |               |      |                  | Acceleration/deceleration time selection for last 8 segments |

This parameter set is only effective when F080 is set as 1. The setting methods of acceleration/deceleration time for internally controlled multi-stage speed and segment speed are as follows:

Acceleration/deceleration time is determined by binary 2bit

| Bit1 | Bit0 | 加减速时间  |
|------|------|--|
| 0    | 0    | First acceleration/deceleration time F014, F015  |
| 0    | 1    | Second acceleration/deceleration time F016, F017 |
| 1    | 0    | Third acceleration/deceleration time F018, F019  |
| 1    | 1    | Fourth acceleration/deceleration time F020, F021 |

Acceleration/deceleration time for each segment is determined by binary 16bit

| Eighth segment speed |   | Seventh segment speed |   | Sixth segment speed |   | Fifth segment speed |   | Fourth segment speed |   | Third segment speed |   | Second segment speed |   | First segment speed |   |
|----------------------|---|-----------------------|---|---------------------|---|---------------------|---|----------------------|---|---------------------|---|----------------------|---|---------------------|---|
| t8                   |   | t7                    |   | t6                  |   | t5                  |   | t4                   |   | t3                  |   | t2                   |   | t1                  |   |
| 0                    | 0 | 0                     | 0 | 0                   | 0 | 0                   | 0 | 0                    | 1 | 1                   | 0 | 0                    | 0 | 1                   | 1 |

t1 acceleration/deceleration time IV

t2 acceleration/deceleration time I

t3 acceleration/deceleration time III set value

t4 acceleration/deceleration time II  $1 \times 2^0 + 1 \times 2^1 + 1 \times 2^5 + 1 \times 2^6 = 99$

t5 acceleration/deceleration time I F084 is set as 99

t6 acceleration/deceleration time I Attached:  $2^0=1$   $2^1=2$   $2^2=4$   $2^3=8$

t7 acceleration/deceleration time I  $2^4=16$   $2^5=32$   $2^6=64$   $2^7=128$

t8 acceleration/deceleration time I

F085 is a selection for the acceleration/deceleration time of last 8 segments (calculation

method is the same as that for F084)

| F086                   | Setting Range | Unit    | Ex-factory Value | Alteration |
|------------------------|---------------|---------|------------------|------------|
| Frequency II setting   | 0.0~1000.0 Hz | 0.01 Hz | 15               | ○          |
| F087                   |               |         | 20               |            |
| Frequency III setting  |               |         | 25               |            |
| F088                   |               |         | 30               |            |
| Frequency IV setting   |               |         | 35               |            |
| F089                   |               |         | 40               |            |
| Frequency V setting    |               |         | 0.5              |            |
| F090                   |               |         | 10               |            |
| Frequency VI setting   |               |         | 15               |            |
| F091                   |               |         | 20               |            |
| Frequency VII setting  |               |         | 25               |            |
| F092                   |               |         | 30               |            |
| Frequency VIII setting |               |         | 35               |            |
| F093                   |               |         | 40               |            |
| Frequency IX setting   |               |         | 45               |            |
| F094                   |               |         |                  |            |
| Frequency X setting    |               |         |                  |            |
| F095                   |               |         |                  |            |
| Frequency XI setting   |               |         |                  |            |
| F096                   |               |         |                  |            |
| Frequency XII setting  |               |         |                  |            |
| F097                   |               |         |                  |            |
| Frequency XIII setting |               |         |                  |            |
| F098                   |               |         |                  |            |
| Frequency XIV setting  |               |         |                  |            |
| F099                   |               |         |                  |            |
| Frequency XV setting   |               |         |                  |            |
| F100                   |               |         |                  |            |

|                       |  |  |  |  |
|-----------------------|--|--|--|--|
| Frequency XVI setting |  |  |  |  |
|-----------------------|--|--|--|--|

The parameter can be set, combining multi-function input terminals, with externally controlled 4-segment speed, externally controlled multi-segment speed and internally controlled multi-segment speed selectable. Refer to F080 and F086-F100 description for details about related parameters.

| F101       | Setting Range | Unit | Ex-factory Value | Alteration |
|------------|---------------|------|------------------|------------|
| Timer I    | 0.0~6500.0s   | 0.1s | 10.0             | ○          |
| F102       |               |      | 10.0             |            |
| Timer II   |               |      | 0.0              |            |
| F103       |               |      | 0.0              |            |
| Timer III  |               |      | 0.0              |            |
| F104       |               |      | 0.0              |            |
| Timer IV   |               |      | 0.0              |            |
| F105       |               |      | 0.0              |            |
| Timer V    |               |      | 0.0              |            |
| F106       |               |      | 0.0              |            |
| Timer VI   |               |      | 0.0              |            |
| F107       |               |      | 0.0              |            |
| Timer VII  |               |      | 0.0              |            |
| F108       |               |      | 0.0              |            |
| Timer VIII |               |      | 0.0              |            |
| F109       | 0.0           |      |                  |            |
| Timer IX   | 0.0           |      |                  |            |
| F110       | 0.0           |      |                  |            |
| Timer X    | 0.0           |      |                  |            |
| F111       | 0.0           |      |                  |            |
| Timer XI   | 0.0           |      |                  |            |
| F112       | 0.0           |      |                  |            |
| Timer XII  | 0.0           |      |                  |            |
| F113       | 0.0           |      |                  |            |
| Timer XIII | 0.0           |      |                  |            |
| F114       | 0.0           |      |                  |            |
| Timer XIV  | 0.0           |      |                  |            |
| F115       | 0.0           |      |                  |            |

|             |  |  |     |  |
|-------------|--|--|-----|--|
| Timer XV    |  |  |     |  |
| <b>F116</b> |  |  | 0.0 |  |
| Timer XVI   |  |  |     |  |

The parameter setting is applicable to the running time setting for internally controlled multi-segment speed and draft actuation. Refer to F080 and F101-F116 description for details about related parameters.

| F117   | Setting Range | Unit | Ex-factory Value | Alteration |
|--|---------------|------|------------------|------------|
| Memory function for internally controlled multi-segment speed (UP.DOWN power down reserve) | 0~1           | 1    | 0                | ×          |

0: Not memorized 1: Memorized

This parameter determines the pause function during VFD control at internally controlled multi-segment speed; when F117=1, it can memorize the VFD operating state, and can even memorize during stop or failure, then continue to run after back to normal; when F117=0, memorizing is unavailable.

When use UP and Down function, the parameter and F077 can realize UP and DOWN Timer power down reverse function. When F077=1, UP and DOWN timer memorize during stop. Meanwhile if F177=1, UP and DOWN timer power down reserve.

## 6.6 Protection function parameters

| F118                                      | Setting range | Unit | Ex-factory value | Alteration |
|---|---------------|------|------------------|------------|
| Selection of overvoltage stall prevention | 0-1           | 1    | 1                | ×          |

0: Overvoltage stall prevention function is invalid

1: Overvoltage stall prevention function is valid

During VFD deceleration, the motor shall produce rebound energy into VFD under the influence of load inertia to make the voltage on VFD DC side rise; while overvoltage stall function is started and VFD DC voltage is overhigh, the VFD shall stop decelerating till DC side voltage is lower than set value, and for the VFD is decelerating, deceleration time shall automatically prolong.

| F119                            | Setting range | Unit | Ex-factory value | Alteration |
|---------------------------------|---------------|------|------------------|------------|
| Stall level during acceleration | 0-200%        | 1%   | 150              | ×          |

During VFD acceleration, output current of the VFD shall rise rapidly due to overload or excessively short acceleration time, and the VFD shall stop accelerating while exceeding rated set level; when the current is lower than set value, the VFD shall continue accelerating.

[Note] 100% current refers to rated current of the motor, and when the parameter is set to 0,

stall prevention function is invalid during acceleration.

| F120                              | Setting range | Unit | Ex-factory value | Alteration |
|-----------------------------------|---------------|------|------------------|------------|
| Stall level during constant speed | 0-200%        | 1%   | 0                | ×          |

During constant running of variable frequency accelerator, the current increases due to fluctuation of load or other reason; when the current exceeds rated set value, the VFD shall decrease output frequency, and if output current returns to normal, the VFD shall reaccelerate up to set frequency.

| F121   | Setting range | Unit | Ex-factory value | Alteration |
|--|---------------|------|------------------|------------|
| Deceleration time for stall prevention during constant speed | 0.1-25.5s     | 0.1s | 5.0              | ○          |

When the VFD is applied to the load of fans and pumps, P120 can be set as 120%; when the current of VFD is greater than 120%, output frequency shall decrease, consequently the current shall decrease; however, after the current returns to normal, the frequency also shall become normal gradually, thus achieving stall prevention function; decrease rate of the frequency depends on F121.

| F122                            | Setting range | Unit | Ex-factory value | Alteration |
|---------------------------------|---------------|------|------------------|------------|
| Stall level during deceleration | 200~800V      | 1V   | Model dependent  | ×          |

| F123                                      | Setting range | Unit | Ex-factory value | Alteration |
|---|---------------|------|------------------|------------|
| Selection of over torque detection method | 0-3           | 1    | 0                | ×          |

0: While achieving the frequency, start to detect over torque; after the detection of over torque, continue operating.

1: While achieving the frequency, start to detect over torque; after the detection of over torque, stop operating.

2: Detect the over torque during running; after the detection of over torque, continue operating.

3: Detect the over torque during operating; after the detection of over torque, stop operating.

| F124                        | Setting range | Unit | Ex-factory value | Alteration |
|-----------------------------|---------------|------|------------------|------------|
| Over torque detection level | 0-200%        | 1%   | 0                | ×          |

When output current goes beyond torque detection level and exceeds half of set time value (ex-factory value 1.0s), over torque detection shall be indicated and corresponding multi-function alarm contact shall be actuated; when it exceeds set time value, the VFD shall provide protection, and when this parameter is set to 0, over torque shall not be detected.

| F125                       | Setting range | Unit | Ex-factory value | Alteration |
|----------------------------|---------------|------|------------------|------------|
| Over torque detection time | 0.1-20.0s     | 0.1s | 1.0              | ×          |

When the VFD detects that output current exceeds set motor current, it shall start to calculate over torque time; when over torque time goes beyond half of set detection time value,



corresponding multi-function output terminal shall be actuated with over torque alarm, and the VFD continue operating. In case that over torque time exceeds set detection time value (F125 setting), the VFD shall provide protection, failure information be displayed and the VFD stop outputting.

Refer to F123 and F124 for relevant parameters.

| F126           | Setting range | Unit | Ex-factory value | Alteration |
|----------------|---------------|------|------------------|------------|
| Counter memory | 0-1           | 0    | 0                | ×          |

0: Not memorized    1: Memorized

Determine whether to memorize counter values after power failure of the VFD via memory function of pulse counter.

| F127 – F129 | Reserve |
|-------------|---------|
|             |         |

## 6.7 Function parameters of constant-pressure water supply

| F130                      | Setting range | Unit | Ex-factory value | Alteration |
|---------------------------|---------------|------|------------------|------------|
| Number of auxiliary pumps | 0-2           | 1    | 0                | ×          |

The quantity of auxiliary pumps shall be set via this parameter; start or stop of auxiliary pumps are realized by using multi-function output contact, and auxiliary pump 1 or 2 shall be controlled through peripheral control circuit.

| F131  | Setting range | Unit | Ex-factory value | Alteration |
|---|---------------|------|------------------|------------|
| Continuous operating time of auxiliary pump | 1-9000 (min)  | 1    | 60               | ×          |

When only one of two pumps is in service, for the purpose of making each pump operating in an average manner, when operating time of one pump reaches P131, the other pump shall be switched for operating.

| F132                                | Setting range | Unit | Ex-factory value | Alteration |
|-------------------------------------|---------------|------|------------------|------------|
| Interlocking time of auxiliary pump | 1-250s        | 1s   | 5                | ○          |

Setting of this parameter shall determine interlocking time of two auxiliary pumps during mutual switching as shown in Figure 6-14.

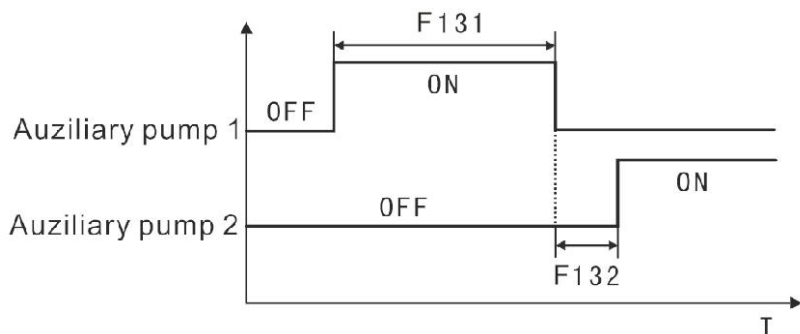

Figure 6-14 Interlocking Time Switching of Auxiliary Pump

| F133                      | Setting range | Unit | Ex-factory value | Alteration |
|---------------------------|---------------|------|------------------|------------|
| High-speed operating time | 1-250s        | 1s   | 60               | ○          |

In the process of applying constant pressure water supply, main pump operates at fast frequency (as set in F060) due to larger water consumption; when high-speed operating time is achieved, corresponding multi-function contact shall be actuated and auxiliary pumps start to operate. Refer to Figure 6-15 for details.

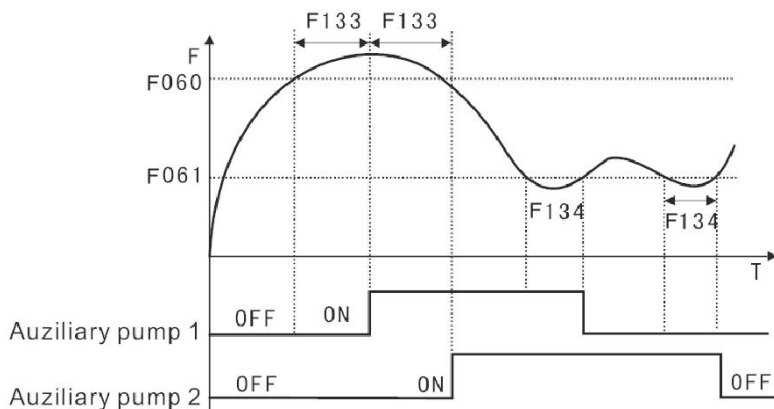

Figure 6-15 High/Low-speed Operating Time Curve of Pump

| F134 | Setting range | Unit | Ex-factory value | Alteration |
|------|---------------|------|------------------|------------|
|------|---------------|------|------------------|------------|

|                          |        |    |    |   |
|--------------------------|--------|----|----|---|
| Low-speed operating time | 1-250s | 1s | 60 | ○ |
|--------------------------|--------|----|----|---|

During the application of constant pressure water supply, when main pump frequency operates at low speed (set via F061) due to reduction of water consumption and low-speed operating time (F134) is achieved, corresponding multi-function contact shall be actuated and auxiliary pumps stop.

F133 and F134 must be used in coordination with F060, F061 and multi-function output terminal and mainly used for addition and reduction of auxiliary pumps. Refer to Figure 6-15 for details.

| F135                            | Setting range | Unit   | Ex-factory value | Alteration |
|---------------------------------|---------------|--------|------------------|------------|
| Shutdown pressure level         | 0-150%        | 1%     | 95               | ○          |
| F136                            | 1-250s        | 1s     | 30               | ○          |
| Shutdown level continuous time  |               |        |                  |            |
| F137                            | 1-150%        | 1%     | 80               | ○          |
| Wake-up level                   |               |        |                  |            |
| F138                            | 0.00-400.0    | 0.01Hz | 20.00            | ○          |
| Sleep frequency                 |               |        |                  |            |
| F139                            | 1-250s        | 1s     | 20               | ○          |
| Sleep frequency continuous time |               |        |                  |            |

Shutdown pressure level mainly refers to pressure level occurring when main pump enters the dormancy state; refer to Figure 6-16 for details.

Shutdown level continuous time refers to the duration time on the condition of shutdown pressure level before going sleep; refer to Figure 6-16 for details.

Wake-up level refers to wake-up pressure level from dormancy state to recovery; refer to Figure 6-16 for details.

Sleep frequency refers to the minimum operating frequency while going sleep; refer to Figure 6-16 for details.

Sleep frequency continuous time refers to continuous time of operating under sleep frequency; refer to Figure 6-16 for details.

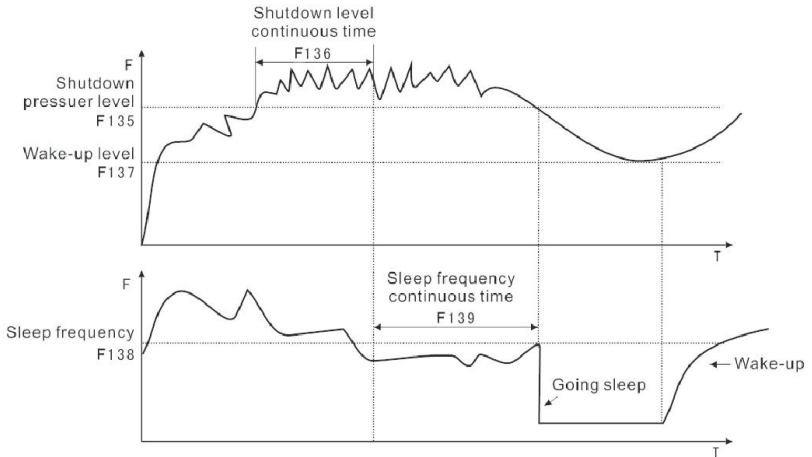

Figure 6-16 Main Pump State Setting and Time Curve

## 6.8 Motor function parameters

| F141                 | Setting range | Unit   | Ex-factory value | Alteration |
|----------------------|---------------|--------|------------------|------------|
| Rated power of motor |               | 0.01KW | *                | ×          |

| F141                   | Setting range | Unit | Ex-factory value | Alteration |
|------------------------|---------------|------|------------------|------------|
| Rated voltage of motor |               | 0.1V | *                | ×          |

It shall be set as per rated voltage value on motor nameplate; ex-factory value of 230V grade VFD and that of 440V grade VFD are respectively 220 and 380.

| F142                   | Setting range | Unit | Ex-factory value | Alteration |
|------------------------|---------------|------|------------------|------------|
| Rated current of motor |               | 0.1A | *                | ×          |

This parameter shall be set according to rated value on motor nameplate and can be used for limiting output current of the VFD so as to prevent over current and protect the motor; in case that motor current exceeds this value, AC motor VFD shall provide the protection.

| F143                  | Setting range | Unit | Ex-factory value | Alteration |
|-----------------------|---------------|------|------------------|------------|
| Number of motor poles | 02-22         | 1    | 04               | ×          |

Number of motor poles shall be determined via this parameter which is set according to motor nameplate.

| F144                 | Setting range | Unit   | Ex-factory value | Alteration |
|----------------------|---------------|--------|------------------|------------|
| Motor rotating speed | 0-60000       | 1r/min | 1440             | ×          |

It shall be set according to actual speed of the motor; displayed value is identical to this parameter and can be used as the parameter used for monitoring to facilitate the user; this set value is corresponding to the rotating speed at 50Hz.

| F145                          | Setting range | Unit | Ex-factory value | Alteration |
|-------------------------------|---------------|------|------------------|------------|
| Automatic torque compensation | 0.0-10.0%     | 1%   | 2.0              | ×          |

This parameter can be used to make the VFD automatically output extra voltage during running and to compensate the insufficient torque of motor during low frequency. Excessive torque compensation is inadvisable and the setting shall be performed upward gradually based on actual situation. Insufficient compensation shall cause insufficient torque of the motor under low frequency while excessive compensation shall induce excessive torque, thus producing certain impact on machinery and even causing VFD tripping. As shown in the Figure 6-17 on the right.

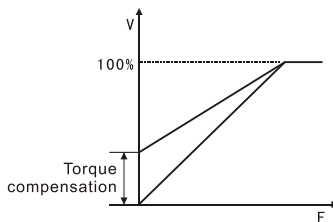

Figure 6-17 Automatic Torque Compensation

| F146                     | Setting range | Unit | Ex-factory value | Alteration |
|--------------------------|---------------|------|------------------|------------|
| No-load current of motor | 0-100%        | 1%   | 40               | ×          |

The setting of motor no-load current shall affect the quantity of slip compensation and rated current of the motor is 100%.

| F147                    | Setting range | Unit | Ex-factory value | Alteration |
|-------------------------|---------------|------|------------------|------------|
| Motor slip compensation | 0.0~2.0       | 0.1  | 1.0              | ×          |

When the VFD drives the motor, both the load and the slippage shall increase, and motor running speed shall be closer to synchronous speed via slip compensation and slippage reduction.

| F148                                     | Setting range | Unit  | Ex-factory value | Alteration |
|--|---------------|-------|------------------|------------|
| Max.frequency of motor slip compensation | 0.0~20.0      | 0.1Hz | 2.0              | ×          |

| F149                             | Setting range | Unit | Ex-factory value | Alteration |
|----------------------------------|---------------|------|------------------|------------|
| Slip compensation filtering time | 0~2000ms      | 1ms  | 20               | ×          |

| F192                    | Setting range | Unit | Ex-factory value | Alteration |
|-------------------------|---------------|------|------------------|------------|
| Motor stator resistance | 0.0~99.99     | 0.01 | *                | ×          |

## V70 Series High Performance Vector Control Mini VFD

| F193                   | Setting range | Unit | Ex-factory value | Alteration |
|------------------------|---------------|------|------------------|------------|
| Motor rotor resistance | 0.0~99.99     | 0.01 | *                | ×          |

| F194                       | Setting range | Unit | Ex-factory value | Alteration |
|----------------------------|---------------|------|------------------|------------|
| Mutual inductance of motor | 0.0~99.99     | 0.01 | *                | ×          |

| F195             | Setting range | Unit | Ex-factory value | Alteration |
|------------------|---------------|------|------------------|------------|
| Leakage of motor | 0.0~99.99     | 0.01 | *                | ×          |

| F150         | Setting range | Unit | Ex-factory value | Alteration |
|--------------|---------------|------|------------------|------------|
| AVR function | 0-1           | 1    | 1                | ×          |

0: Invalid 1: Valid

AVR function refers to automatic voltage regulation. On the condition of unstable input power, in case of overhigh voltage, the running of motor under the power supply exceeding rated voltage shall cause temperature rise of the motor, damage the insulation and make output torque unstable; however, automatic voltage regulation can be used to automatically regulate output voltage at rated voltage of the motor.

When this function set is invalid, output voltage shall fluctuate.

| F151                             | Setting range | Unit | Ex-factory value | Alteration |
|----------------------------------|---------------|------|------------------|------------|
| Automatic energy-saving function | 0.0-20.0%     | 0.1% | 0.0              | ×          |

Automatic energy saving function is invalid while at 0; during acceleration and deceleration, it shall run with full voltage; during constant speed running, the optimum voltage value shall be calculated via load power and supplied to the load to achieving the purpose of energy saving.

| F152               | Setting range | Unit | Ex-factory value | Alteration |
|--------------------|---------------|------|------------------|------------|
| Fault restart time | 0.2-25s       | 0.1s | 1.0              | ○          |

When the VFD is set in the mode of fault restart, after the duration of VFD fault tripping exceeds the time as set in F152, the VFD shall be restarted. Attention must be paid to the safety during the application of this function.

| F153                            | Setting range | Unit | Ex-factory value | Alteration |
|---------------------------------|---------------|------|------------------|------------|
| Power failure restart selection | 0-1           | 1    | 0                | ×          |

0: Power failure restart is invalid No longer restart after momentary outage

1: Frequency tracking startup Please refer to F025 description

| F154                      | Setting range | Unit | Ex-factory value | Alteration |
|---------------------------|---------------|------|------------------|------------|
| Allowable outage duration | 0.1-5.0s      | 0.1s | 0.5              | ×          |

The maximum duration of outage can be determined via this parameter; in case of going beyond set time, the VFD shall still stop outputting after power recovery; restart shall proceed as per general startup sequence.

| F155                   | Setting range | Unit | Ex-factory value | Alteration |
|------------------------|---------------|------|------------------|------------|
| Times of fault restart | 00-10         | 1    | 00               | ×          |

The VFD shall be automatically reset and restarted in case of abnormal situation (such as overcurrent and overvoltage); in case of common starting mode, this mode shall be followed; in case of frequency tracking start, the start shall be conducted in the manner of tracking start. After starting, if no anomaly occurs within 60s, set times shall be recovered; if any anomaly occurs and set number is achieved, the converter shall no longer output, and restart shall be conducted after resetting. If F155 is at 0, no automatic reset or restart function shall be performed in case of anomaly.

## 6.9 PID function parameters

| F156                      | Setting range | Unit | Ex-factory value | Alteration |
|---------------------------|---------------|------|------------------|------------|
| Proportional constant (P) | 0.0-1000.0%   | 0.1% | 100.0            | ○          |

Error value gain is set for proportional constant; in case of I=0 and D=0, only proportional control shall be actuated.

| F157                 | Setting range | Unit | Ex-factory value | Alteration |
|----------------------|---------------|------|------------------|------------|
| Integration time (I) | 0.1-3600.0s   | 0.1s | 5.0              | ○          |

Response speed of PID actuation is set via integration time (I); the larger I value is, the slower the response speed is; contrarily, faster response speed and small integration time shall cause the oscillation.

| F158                | Setting range | Unit  | Ex-factory value | Alteration |
|---------------------|---------------|-------|------------------|------------|
| Derivation time (D) | 0.01-10.00s   | 0.01s | 0                | ○          |

The attenuation of PID actuation is set via derivation time (D); the larger D value is, the more obvious the attenuation is; D=0 indicate that no effect is produced, that is, invalid.

| F159         | Setting range | Unit | Ex-factory value | Alteration |
|--------------|---------------|------|------------------|------------|
| Target value | 0-100.0%      | 1%   | *                | ○          |

Control target value can be set via external voltage signal or panel, and 100% target value is corresponding to the frequency at +10V analog.

PID closed-loop control is generally used for controlling the process with slow change in physical quantity, such as controlling pressure and temperature; generally feedback signal is acquired from temperature transmitter and pressure transmitter; during PID control, feedback signal input channel is analog current signal of 4-20mA.

PID closed-loop control is valid during starting of multi-function input PID. Generally adjustment method of PID control is as follows:

- 1) Correctly select the VFD, and use the VFD with the input specification in accordance with standard signal of 4-20mA;
- 2) Correctly set target value;
- 3) In case of nonoscillatory input, increase proportionality constant P;
- 4) In case of nonoscillatory input, decrease integration time I;

- 5) In case of nonoscillatory input, increase the derivation D;  
 6) Refer to the descriptions in Figure 6-19/6-20 for specific application.  
 PID control block is shown in Figure 6-18:

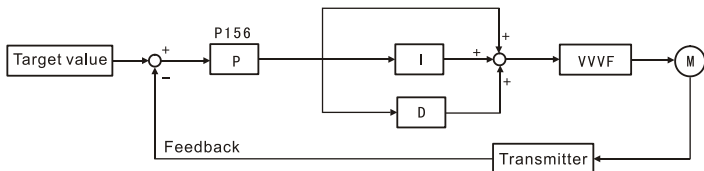

Figure 6-18 PID Control Block Diagram

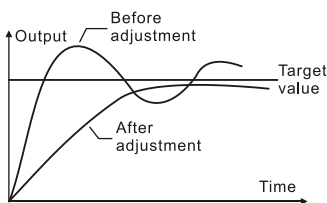

Figure 6-19 Suppress Output Exceeding of PID Control

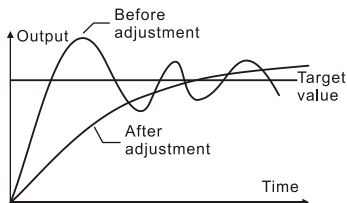

Figure 6-20 Suppress Output Oscillation of PID Control

(1) Suppress output exceeding

- a: Decrease derivation time (D value)  
 b: Extend integration time (I value)

(2) Suppress output oscillation

- a: Decrease derivation time (D value) or set it as 0  
 b: Decrease proportionality constant (P value)

| F160                | Setting range | Unit | Ex-factory value | Alteration |
|---------------------|---------------|------|------------------|------------|
| PID channel setting | 0-1           | 1    | 10               | ×          |

0: PID target value refers to the value set as in F159.

1: PID target value refers to the value of external analog 0-10V (corresponding to 0-100%) and the value set as in F159 is invalid. Target value selection can be set via selection panel and external analog which is 0-10V signal or set through potentiometer.

Unit's digit set PID given channel:

0:F159 given      1: AI1      2: AI2

Ten's digit PID feedback channel

0:AI1      1: AI2



| F161            | Setting range | Unit | Ex-factory value | Alteration |
|-----------------|---------------|------|------------------|------------|
| PID upper limit | 0 ~ 100%      | 1%   | 100              | ○          |

When PID feedback value is greater than set value in P161, corresponding multi-function output terminal shall be actuated and the machine shall not shut down.

| F162            | Setting range | Unit | Ex-factory value | Alteration |
|-----------------|---------------|------|------------------|------------|
| PID lower limit | 0 ~ 100%      | 1%   | 0                | ○          |

When PID feedback value is less than set value in F162, corresponding multi-function output terminal shall be actuated and the machine shall not shut down.

## 6.10 Communication function parameters

| F163                  | Setting range | Unit | Ex-factory value | Alteration |
|-----------------------|---------------|------|------------------|------------|
| Communication address | 0-250         | 1    | 1                | ×          |

When RS-485 communication port control is set for the VFD, the position of each VFD shall be set via a parameter.

0: No communication function

01-250: Position of VFD

| F164                             | Setting range | Unit | Ex-factory value | Alteration |
|----------------------------------|---------------|------|------------------|------------|
| Communication transmission speed | 0-3           | 1    | 2                | ×          |

0:4800 bit/s

1:9600 bit/s

2:19200 bit/s

3:38400 bit/s

| F165                    | Setting range | Unit | Ex-factory value | Alteration |
|-------------------------|---------------|------|------------------|------------|
| Communication data mode | 0-5           | 1    | 3                | ×          |

0: 8N1 For ASCII

1: 8E1 For ASCII

2: 8O1 For ASCII

3: 8N1 For RTU

4: 8E1 For RTU

5: 8O1 For RTU

[Note] 8N1 For ASCII F165=0 or 8N1 For RTU F165=3

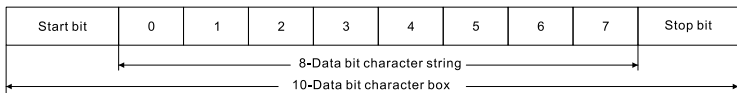

8E1 For ASCII F165=1 or 8E1 For RTU F165=4

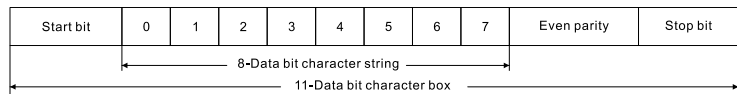

8O1 For ASCII F165=2 or 8O1 For RTU F165=5

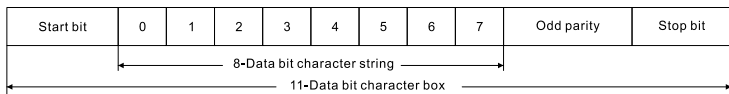

|           |         |
|-----------|---------|
| F166-F168 | Reserve |
|-----------|---------|

| F169                             | Setting range | Unit | Ex-factory value | Alteration |
|----------------------------------|---------------|------|------------------|------------|
| Communication protocol selection | 0-1           | 1    | 1                | ×          |

0: Standard Modbus protocol

1: V70 communication protocol

### Standard Modbus Communication Protocol

(1) V70 series converters support RTU mode in standard Modbus protocol.

RTU mode: Each 8bit data is composed of two hexadecimal characters of 4bit, for example: 64H (hex).

|                     | RTU Mode      |
|---------------------|---------------|
| Start bit           | 3.5 bits      |
| Slave address       | 1 bit         |
| Modbus function NO. | 1 bit         |
| Data                | n bit         |
| CHECK               | CRC16 (2 bit) |
| End bit             | 3.5 bits      |

VFD parameters communication address indicate hexadecimal system, for example communication address of F100 is 0064H.

Communication specific variables: including communication specific instruction variables and communication specific state variables, address starting from 0200H.

Save of communication variables: rewritten VFD parameters (for example F100) to be stored in EEPROM. Still save after power failure. But parameters cannot be rewritten frequently, otherwise EEPROM memory may be damaged. Rewriting communication-specific variables (variables after 0200H) only modifies values in RAM. Do not save after power failure, it allow rewriting frequently.

Data Types in Communication: because of data is hexadecimal integer, the smallest unit can be seen from the decimal point position of the parameters in the function table. For example, the minimum unit of F003 is 0.1Hz. Therefore, according to Modbus protocol, communication transmission 300 represents 30.0Hz.

Rewritten, of F013 and F172 parameters can only by 06H function, not support by 10H function, and there is no response frame.

### Supported Modbus Function

| Parameter | Function                         | Specification   |
|-----------|----------------------------------|---|
| 01H       | Read parameter address status    | Read from 1 to 32   |
| 03H       | Read holding register            | Read from 1 ~ 20. Read all parameters, communication-specific variables                     |
| 04H       | Read input register              | Read from 1 ~ 20.   |
| 05H       | Write single parameter address   | Write data FF00H, parameter address ON; write 0000H, parameter address OFF                  |
| 06H       | Write single holding register    | All parameters and communication-specific variables can be rewritten                        |
| 0FH       | Write multiple parameter address | Write from 1 ~ 32. parameter address start from 0048H                                       |
| 10H       | Write multiple holding registers | Rewritten from 1 ~ 20. All parameters and communication-specific variables can be rewritten |

**(1) Communication Address table**

## 1) parameter address address table

Modbus mode include: 01H (read parameter address status), 05H (write single parameter address), 0FH (write multiple parameter address)

| parameter address address | Name                        | R/W | Specification                                  |
|---------------------------|-----------------------------|-----|--|
| 0000                      | Operation                   | R   | 0–Stop 1–Operating                             |
| 0001                      | JOG                         | R   | 0–Invalid 1–JOG                                |
| 0002                      | Forward/reverse             | R   | 0–Forward 1–Reverse                            |
| 0003                      | In operation                | R   | 0–Stop 1–In operation                          |
| 0004                      | In jogging                  | R   | 0–Invalid 1–In jogging                         |
| 0005                      | In forward/reverse rotation | R   | 0–In forward rotation<br>1–In reverse rotation |
| 0006                      | In braking                  | R   | 0–Invalid 1–In braking                         |

|           |                        |   |   |
|-----------|------------------------|---|---|
| 0007      | Frequency tracking     | R | 0—Invalid 1—Frequency tracking                    |
| 0008-0047 | reserve                |   |   |
| 0048      | Operation              | W | 0000—Invalid<br>FF00 (or 100, bit8 set 1) — Valid |
| 0049      | Forward                | W | 0000—Invalid FF00—Valid                           |
| 004A      | Reverse                | W | 0000—Invalid FF00—Valid                           |
| 004B      | Stop                   | W | 0000—Invalid FF00—Valid                           |
| 004C      | Forward/reverse switch | W | 0000—Invalid FF00—Valid                           |
| 004D      | JOG                    | W | 0000—Invalid FF00—Valid                           |
| 004E      | JOG Forward            | W | 0000—Invalid FF00—Valid                           |
| 004F      | JOG Reverse            | W | 0000—Invalid FF00—Valid                           |

## 2) Input register address table

All address only read. Modbus function include 04H (read input register) .

Fault Code table:

| Address | Name                  |
|---------|-----------------------|
| 0000    | Output frequency      |
| 0001    | Set frequency         |
| 0002    | Output current        |
| 0003    | Output speed          |
| 0004    | DC voltage            |
| 0005    | AC voltage            |
| 0006    | temperature           |
| 0007    | Counter               |
| 0008    | PID target value      |
| 0009    | PID feedback value    |
| 000A    | Current fault         |
| 000B    | Total operating hours |

| 000C    | Output power     |
|---------|------------------|
| 000D    | X terminal state |
| Decimal | Fault code       |
| 64      | E.OCS            |
| 80      | E.oUS            |
| 88      | E.LuS            |
| 92      | E.oHS            |
| 96      | E.oLS            |
| 100     | E.oAS            |
| 104     | E.oTS            |

Note 1: The BIT0-BIT5 in X terminal state corresponds to the X1-X6 terminal , and 1 means terminal is closed.

Note 2: The fault code suffixes S, A, d and n are four consecutive numbers, such as 65 for E.O.C.A.

### 3) Holding register address table

Modbus functions include: 03H (read and hold register), 06H (write a single hold register), 10H (write multiple hold registers)

| Definition  | Address     | Specification  |
|---|-------------|--|
| Internal parameters                               | 0000H~00FFH | VFD parameter address, F000~F255   |
| Communication                                     | 0200H       | Main control bit, BIT0-BIT7 mapping parameter address 0048H~004FH , BIT8 virtual input terminal enable   |
| Specific Instruction                              | 0201H       | Given frequency , given frequency address when F002=2  |
| Variable  | 0202H       | Virtual input terminal1, BIT0-BIT15 corresponding digital input terminal function 01-16. Digital input terminal function 1-8 already exists in the main control bit, the modification here is invalid. |
|   | 0203H       | Virtual input terminal 2, BIT0-BIT15 corresponding digital input terminal function 17-32   |
|   | 0204H       | EDO , Communication control digital output terminal, BIT3 corresponding (FA, FB, FC) relay terminal  |
|   | 0205H       | EAO, Communication control analog output terminal AO   |
|   | 0206H~020FH | Reverse  |
| Communication-specific state variables, read-only | 0210H       | Main control bit , BIT0 ~ BIT15 mapping parameter address 0000H~000FH  |
|   | 0211H       | Digital terminal status, BIT0-BIT5 corresponding X1-X6 , BIT11 corresponding (FA, FB, FC) relay  |
|   | 0212H       | Virtual Output State 1, BIT0-BIT15 corresponding to Digital Output Terminal Function 01~16.  |
|   | 0213H       | Virtual output state 2, BIT0-BIT15 corresponds to digital output terminal function 17-32.  |
|   | 0214H-021FH | Reverse  |

|             |   |
|-------------|---|
| 0220H~022DH | Mapping input registers (addresses 0000H-000DH) |
| 022EH       | AI1. Analog input value 1 (0~100.00%)           |
| 022FH       | AI2. Analog input value 2 (0~100.00%)           |
| 0230H       | PFI. Pulse input value                          |
| 0231H~023FH | Reverse   |

**(1) For example**

- Setting No.01 VFD given frequency is 300.0Hz, Application Function Code 06H. Given frequency is communication port (F002=2) .

Master command message:

|                              | RTU Mode           |
|------------------------------|--------------------|
| START                        |                    |
| Slave address                | 01H                |
| Modbus function NO.          | 06H                |
| High bit of register address | 02H                |
| Low bit of register address  | 01H                |
| High bit of written data     | 0BH                |
| Low bit of written data      | B8H                |
| Check                        | DEH (CRC low bit)  |
|                              | F0H (CRC high bit) |
| END                          | 3.5 bit            |

Slave response : frequency is set to 300.0Hz, returns the same data as the master requests.

Note 1: When F002 = 2, use 06H or 10H function to rewrite frequency, address is 0201H, EEPROM is not operated at this time.

If the rewriting frequency is to be written to EEPROM, the F003 value needs to be rewritten.

Note 2: Calculations of check bits

RTU mode adopts CRC method. The C language code of CRC16 is as follows:

```

unsigned char data          // Indicators of information buffer
unsigned char length       //Number of bytes in the information buffer
unsigned int crc_chk(unsigned char data,unsigned char length)
{
    int j;
    unsigned int reg_crc=0xffff;
    while(length--){
        reg_crc^=*data++;
        for(j=0;j<8;j++){

```

```

        if(reg_crc&0x01)
            reg_crc=(reg_crc>>1)^0xa001;
        else
            reg_crc=reg_crc>>1;
    }
}
return reg_crc;
}

```

2. Make No. 01 VFD run, function code 05H or 06H. Requirement control mode is communication port (F001=2) .  
0FH and 10H can also achieve this function as multi-write modes. See the following examples for their formats.

Master command message:

|  | Write parameter address | Write hold register |
|--|-------------------------|---------------------|
| Slave address                                  | 01H                     | 01H                 |
| Modbus function number                         | 05H                     | 06H                 |
| High bit of parameter address/register address | 00H                     | 02H                 |
| Low bit of parameter address/register address  | 48H                     | 00H                 |
| High bit of write data                         | FFH                     | 00H                 |
| Low bit of write data                          | 00H                     | 01H                 |
| CRC  | ——                      | ——                  |

Slave response: VFD is forward operation and returns the same data as the master requests.

3. Read 01 slave running status, function code 01H or 03H.

Master command message:

|  | Read parameter address | Read hold register |
|--|------------------------|--------------------|
| Slave address  | 01H                    | 01H                |
| Modbus function number                               | 01H                    | 03H                |
| High bit of parameter address/register start address | 00H                    | 02H                |
| Low bit of parameter address/register                | 00H                    | 10H                |

|  |     |     |
|--|-----|-----|
| start address                                      |     |     |
| Read parameter address/register quantity(high bit) | 00H | 00H |
| Read parameter address/register quantity(low bit)  | 08H | 01H |
| CRC  | —   | —   |

Slave response: 09H to 00001001B, comparing with the parameter address table, it indicates that VFD on command and operating.

|                        | Read parameter address | Read hold register |
|------------------------|------------------------|--------------------|
| Slave address          | 01H                    | 01H                |
| Modbus function number | 01H                    | 03H                |
| Byte number            | 01H                    | 02H                |
| Read data              | 09H                    | 00H                |
|                        |                        | 09H                |
| CRC                    | —                      | —                  |

4. Read the operating frequency and setting frequency of No. 01 VFD, function code 04H or 03H.

Master command message:

|   | Read input register | Read hold register |
|---|---------------------|--------------------|
| Slave address                                 | 01H                 | 01H                |
| Modbus function number                        | 04H                 | 03H                |
| High bit of input/hold register start address | 00H                 | 02H                |
| Low bit of input/hold register start address  | 00H                 | 20H                |
| Read byte number(high bit)                    | 00H                 | 00H                |
| Read byte number(low bit)                     | 02H                 | 02H                |
| CRC   | —                   | —                  |

Slave response: The return content indicates that the current frequency of VFD is 0.0Hz and the set frequency is 50.0Hz.

|  | Read input | Read hold register |
|--|------------|--------------------|
|--|------------|--------------------|



|                                     | register |     |
|-------------------------------------|----------|-----|
| Slave address                       | 01H      | 01H |
| Modbus function number              | 04H      | 03H |
| Return byte number                  | 04H      | 04H |
| High bit of first register content  | 00H      | 00H |
| Low bit of first register content   | 00H      | 00H |
| High bit of second register content | 01H      | 01H |
| Low bit of second register content  | F4H      | F4H |
| CRC                                 | —        | —   |

5. Write 20.0s for F014, 15.0s for F015 and 10H for function code.  
Master command message:

|                                     |        |
|-------------------------------------|--------|
| Slave address                       | 01H    |
| Modbus function number              | 10H    |
| Start address (high bit)            | 00H    |
| Start address (low bit)             | 0EH    |
| Register number(high bit)           | 00H    |
| Register number(low bit)            | 02H    |
| Byte number                         | 04H    |
| High bit of first number            | 00H    |
| Low bit of first register content   | C8H    |
| High bit of second register content | 00H    |
| High bit of second register content | 96H    |
| CRC                                 | —<br>— |

Slave response:

|                           |     |
|---------------------------|-----|
| Slave address             | 01H |
| Modbus function number    | 10H |
| Start address (high bit)  | 00H |
| Start address (low bit)   | 0EH |
| Register number(high bit) | 00H |
| Register number(low bit)  | 02H |

CRC

Abnormal response frame: When the slave station cannot complete the request sent by the master station, the abnormal response frame is returned. The frame format is as follows:

|  |
|--|
| 1 bit  |
| 1 bit (Modbus function number+80H)   |
| 1bit:<br>01: Modbus function number that cannot be processed<br>02: Unreasonable data address<br>03: Out-of-range data values<br>04: Operation failure (write read-only parameters, change parameters that cannot be changed during operation, etc.) |
| _____  |

## 6.11 Monitoring function parameters

| F170                             | Setting range | Unit | Ex-factory value | Alteration |
|----------------------------------|---------------|------|------------------|------------|
| Selection of displayed content 1 | 0-11          | 1    | 4                | ○          |

| F171                             | Setting range | Unit | Ex-factory value | Alteration |
|----------------------------------|---------------|------|------------------|------------|
| Selection of displayed content 2 | 0-11          | 1    | 5                | ○          |

This parameter is set to select PID feedback value and other contents to display, thus in favor of monitoring by the user, and the contents is displayed one by one through switching key; in respect of displayed contents, upon shipping out of factory, operating frequency, set frequency, current and AC voltage are defaulted to be displayed, and if other contents are required be monitored; P170 and P171 can be set for the purpose as below:

- 0: no display      1: PID feedback value      2: running speed      3: PID target value  
 4: DC voltage      5: heat sink temperature      6: Counter value      7: output torque  
 8: Input terminal status      9: AI1      10: AI2      11: PFI

| F172           | Setting range | Unit | Ex-factory value | Alteration |
|----------------|---------------|------|------------------|------------|
| Fault clearing | 00-10         | 1    | 0                | △          |

01 refers to fault clearing function and the others are reserved items in factory.

V70 Series High Performance Vector Control Mini VFD

| F173                 | Setting range | Unit | Ex-factory value | Alteration |
|----------------------|---------------|------|------------------|------------|
| Rated voltage of VFD | *             | 1    | *                | △          |

It is the value set in factory according to the model and read-only parameter; alteration is inapplicable.

| F174                 | Setting range | Unit | Ex-factory value | Alteration |
|----------------------|---------------|------|------------------|------------|
| Rated current of VFD | *             | 1    | *                | △          |

It is the value set in factory according to the model and read-only parameter; alteration is inapplicable.

| F175     | Setting range | Unit | Ex-factory value | Alteration |
|----------|---------------|------|------------------|------------|
| VFD type | 0-1           | 1    |                  | △          |

0: Constant torque      1: Fans

Read-only parameter, alteration inapplicable.

| F176                       | Setting range | Unit | Ex-factory value | Alteration |
|----------------------------|---------------|------|------------------|------------|
| Standard for VFD frequency | 0-1           | 1    | 0                | △          |

0:50Hz                      1:60Hz

The value set in factory, read-only parameter, monitoring applicable and alteration inapplicable.

| F177               | Setting range | Unit | Ex-factory value | Alteration |
|--------------------|---------------|------|------------------|------------|
| Unexpected error 1 |               |      | *                | △          |
| F178               |               |      |                  |            |
| Unexpected error 2 |               |      |                  |            |
| F179               |               |      |                  |            |
| Unexpected error 3 |               |      |                  |            |
| F180               |               |      |                  |            |
| Unexpected error 4 |               |      |                  |            |

Check fault display via access to this parameter; no fault record, display —.

| F181                 | Setting range | Unit | Ex-factory value | Alteration |
|----------------------|---------------|------|------------------|------------|
| Software version No. | 0~10.00       | 0.01 | -                | △          |

Check software version No. via 01 setting.

| F182                    | Setting range | Unit | Ex-factory value | Alteration |
|-------------------------|---------------|------|------------------|------------|
| Running time            | 0~3600        | 1s   | -                | △          |
| F183                    | Setting range | Unit | Ex-factory value | Alteration |
| Cumulative running time | 0~65535       | 1h   | -                | △          |

Cumulative running time of VFD

V70 Series High Performance Vector Control Mini VFD

| F184                      | Setting range | Unit  | Ex-factory value | Alteration |
|---------------------------|---------------|-------|------------------|------------|
| Speed display coefficient | 0.000~9.999   | 0.001 | 1.000            | Δ          |

When F170 or F171 select 2 (running speed), the value displayed on the keyboard = actual running speed × F184.

| F185                              | Setting range | Unit | Ex-factory value | Alteration |
|-----------------------------------|---------------|------|------------------|------------|
| Start up preset display selection | 00~10         | 1    | 0                | Δ          |

F185 means start display volume of VFD after power-on.

|           |         |
|-----------|---------|
| F184~F250 | Reserve |
|-----------|---------|

## NO.7 Maintenance and Fault Information

Regular maintenance and inspection during the application shall make your VFD in normal condition for long period.

### 7.1 Maintenance and inspection cautions

- 1 Be sure to first cut off power supply of VFD (L1. L2. L3.L.N) during maintenance and inspection.
- 2 Be sure cut off power supply of the VFD and make the display disappear; conduct maintenance and inspection till high-voltage indicator is off.
- 3 Never pull up or mismatch internal power supply, wires and cables during the inspection; otherwise the VFD shall not operate or be damaged.
- 4 During installation, do not leave the screws and other fittings inside the VFD so as to avoiding short circuit of circuit board.
- 5 After the installation, keep the VFD clean and prevent the dust, oil mist or moisture invading.

### 7.2 Regular inspection items

- 1 Confirm the voltage meets the demand of VFD;  
(In particular, pay special attention to the damage of power line and motor)
- 2 Whether the terminal and connector are loose;  
(Whether power line and terminal connecting line suffer from strand breakage)
- 3 Whether there is dust, scrap iron and corrosive liquids inside the VFD;
- 4 Prohibit measuring insulation impedance of the VFD;
- 5 Measure output voltage, output current and output frequency of the VFD;  
(avoid big difference in measurement results)
- 6 Inspect whether the ambient temperature is around  $-5^{\circ}\text{C}$ - $40^{\circ}\text{C}$  and installation environment has good ventilation;
- 7 Keep the humidity below 90% (without condensing into water droplet);
- 8 Whether there is abnormal sound or abnormal vibration during the running (avoid placing the VFD in the place with severe vibration);
- 9 Please regularly clean venthole.

### 7.3 Fault information and fault clearing

VFDs of V70 feature more perfect protection function in terms of overload, interphase short circuit, earthing short circuit, undervoltage, overheating and overcurrent, etc. In case of occurrence of VFD protection, ascertain the cause as per the information shown below. After handling, perform the running operation newly; if incapable of handling, please contact local dealer.

| Fault display          | Fault content and description | Handling method   |
|------------------------|-------------------------------|---|
| <b>E.o.c</b><br>(E.oc) | Overcurrent during running    | 1: Inspect whether the motor is in short circuit/ partial short circuit and the insulation of output line is in good condition<br>2: Inspect whether the motor is locked and mechanical |

|                         |                                    |   |
|-------------------------|------------------------------------|---|
|                         |                                    | <p>load changes abruptly</p> <p>3: Extend acceleration time or deceleration time</p> <p>4: Reducing torque boost value</p> <p>5: Whether network voltage changes abruptly</p> <p>6: DC braking amount is too large, so reduce it</p> <p>7: Unreasonable VFD configuration, increase the capacity of VFD</p> |
| <i>E.Ou</i><br>(E.Ou)   | Overvoltage during running         | <p>1: Extend deceleration time or install brake resistor</p> <p>2: Whether network voltage changes abruptly</p>   |
| <i>E.Lu</i><br>(E.Lu)   | Variable frequency low voltage     | <p>1: Inspect network voltage 2: Send for repair</p>  |
| <i>E.oH</i><br>(E.oH)   | VFD overheating                    | <p>1: Inspect whether the fan is locked and radiating fin is free of foreign matter</p> <p>2: Whether ambient temperature is normal</p> <p>3: Whether there is air space enough for air convection</p> <p>4: Inspect whether the thermistor and connecting line are in open circuit</p>                     |
| <i>E.FoP</i><br>(E.FoP) | VFD power tube protection          | <p>1: Inspect whether the motor is in short circuit/ partial short circuit</p> <p>2: Inspect whether insulation of output line is in good condition</p> <p>3: Send for repair</p>   |
| <i>E.GFF</i><br>(E.GFF) | Short circuit to ground            | <p>1: Inspect whether the motor is in short circuit</p> <p>2: Inspect whether insulation of output line is in good condition</p> <p>3: Send for repair</p>  |
| <i>E.oLd</i><br>(E.oLd) | VFD overloading 150%<br>For 1min   | <p>1: Inspect whether the capacity of VFD is too small; if yes, increase the capacity</p> <p>2: Inspect whether mechanical load is locked</p> <p>3: Poor V/F curve setting, so reset</p>  |
| <i>E.oLL</i><br>(E.oLL) | Motor overloading 150%<br>For 1min | <p>1: Whether mechanical load changes abruptly</p> <p>2: Too small motor adapted</p> <p>3: Heating insulation of the motor becomes poor</p> <p>4: Whether the voltage fluctuates greatly</p> <p>5: Whether open-phase exists</p> <p>6: Mechanical load increases</p>  |
| <i>E.PLo</i><br>(E.PLo) | Output phase lost                  | <p>1: whether the three-phase stator windings of the motor phase lost</p> <p>2: Inspect output cable</p>  |

|                         |  |  |
|-------------------------|--|--|
| <i>E.PL1</i><br>(E.PL1) | Input phase lost                       | 1: whether power supply input phase lost |
| <i>E.HHC</i><br>(E.HHC) | Abnormal internal communication of VFD | Send for repair                          |
| <i>E.r</i>              | Wrong parameter setting                | Correct parameter setting                |

Code table:

|   |   |     |   |   |   |   |   |     |   |   |   |   |   |   |   |   |
|---|---|-----|---|---|---|---|---|-----|---|---|---|---|---|---|---|---|
| A | b | C,c | d | E | F | G | H | O,o | S | n | L | T | P | r | u | 2 |
| A | b | C   | d | E | F | G | H | O   | S | n | L | T | P | r | u | 2 |

## 7.4 Fault and analysis

### 1. Motor fails to run after operating key is pressed

- (1) Operating mode is set in error, that is, the operating mode is enabled together with external control terminal on the condition of external control terminal.
- (2) Frequency instruction is low level or not given.
- (3) Peripheral wiring is in error, such as wrong two-wire system and three-wire system wiring and relevant parameters setting.
- (4) Setting of multi-function input terminal is in error (on the condition of external control).
- (5) The VFD is in fault protection condition.
- (6) Fault of motor or VFD.

### 2. Parameter setting failure

- (1) Password is locked; conduct setting after decoding.
- (2) The VFD is operating.
- (3) Abnormal connection of connector assemblies and abnormal communication of digital actuator; remove the actuator and reinstall after cutting off power supply.

### 3. Motor fails to reversely rotate

Reverse is prohibited.

### 4. Motor rotates in opposite direction

Motor output connecting line is wrong, it is only necessary to exchange any two connecting lines among U, V and W.

**5. Motor decelerates too slowly**

- (1) Too long deceleration time set, reduce deceleration time.
- (2) Install brake resistor.
- (3) Install DC brake.

**6. Motor overheating**

- (1) The load is too large and actual torque has exceeds rated torque of the motor, so it is proposed to increase the capacity of motor.
- (2) Ambient temperature is overhigh; the motor may be burn out in the environment with high temperature, so it is necessary to reduce ambient temperature of the motor.
- (3) Interphase withstand voltage of the motor is insufficient, on/off action of the VFD shall produce impulse wave among winding coils of the motor; generally the maximum impulse voltage shall be 3 times input power of the VFD, and the motor with interphase impulse withstand voltage higher than the maximum impulse voltage shall be used.

**7. Starting of VFD interferes in other control devices**

- (1) Reduce carrier frequency and the times of internal on/off action.
- (2) Set up noise filter respectively on power input side and output side of the VFD.
- (3) Please properly earth the VFD and motor.
- (4) Encase the cable with metal tube for shielding.
- (5) Separately route main circuit wiring and control line.

**8. Overcurrent stall of VFD is detected during starting of fan**

- (1) When the start is performed, the fan is in idling condition, so DC braking during starting is required to be set.
- (2) DC braking during starting has been set, and it is required to increase DC braking value.

**9. Vibration or roaring of the machine**

- (1) For resonance of vibration frequency of mechanical system and carrier wave, adjust carrier wave to avoid resonance point.
- (2) Resonance of vibration frequency of mechanical system and VFD output frequency.
  - a. Set skipping function to avoid the resonance point;
  - b. Set rubber vibration insulator on bottom board of the motor.

**7.5 Common anomalies and countermeasures**

Analysis, judgment and countermeasures of common anomalies are shown in the table below:

| Anomaly     |                     | Possible causes and countermeasures   |
|-------------|---------------------|---|
| Motor fails | No keyboard display | Inspect whether power failure occurs, input power is in open-phase and input power is connected in error. |



V70 Series High Performance Vector Control Mini VFD

|  |   |   |
|--|---|---|
| to run   | No keyboard display while charging indicator inside is on | Test the connecting wire and socket relating to keyboard are in good condition.<br>Measure the voltage of each control power supply inside to confirm whether switching power supply is in normal operation.<br>In case of abnormal operation of switching power supply, inspect the socket of switching power incoming line (DC+, DC-) is well connected, start-oscillation resistor is damaged or voltage regulator tube is normal.           |
|  | No voltage or low voltage of DC+ and DC- terminals        | Inspect charging circuit.   |
|  | Buzzing of motor  | Too big load of motor, try to reduce it.  |
|  | Anomaly not found   | Confirm whether it is in tripping state or reset is not performed after tripping, whether it is in restarting state after power failure, whether the keyboard is reset, whether program operating state, operating state of multi-segment speed, set operating state or non-operating state is accessed; try restoring ex-factory value to confirm whether operating instruction is provided and inspect whether running frequency is set to 0. |
| Unfavorable acceleration/deceleration of motor |   | Improper setting of acceleration/deceleration time.<br>Too low current limit is set.<br>Overvoltage protection during deceleration.<br>Improper setting of carrier frequency, overloading or oscillation.   |
| Overhigh or overlow motor speed                |   | Improper selection of V/F characteristic.<br>Improper selection of reference for V/F characteristic and resetting shall be performed.<br>Substandard or non-standard rated voltage of the motor.<br>Low voltage of power supply.<br>Wrong setting of frequency signal gain.<br>Wrong setting of output frequency.   |

## No.8 Selection and Configuration of Peripheral Facilities

### 8.1 Options

| Name                                      | Function   |
|---|--|
| Breaker and leakage switch for connection | Protect the connection of VFD, be sure to set breaker on power side, and please use the leakage switch with higher harmonic prevention |
| Electromagnetic contactor                 | Set electromagnetic contactor to prevent burning out brake resistor and connect surge absorber while applying.                         |
| Surge absorber                            | Absorb switching surge current of electromagnetic contactor and relay for controlling  |
| Isolation transformer                     | Isolate input and output effects of the VFD and produce effect on reducing the interference  |
| DC reactor                                | Improve input power factor of the VFD  |
| AC reactor                                | Improve input power factor of the VFD and prevent surge voltage impact   |
| Brake resistor and brake unit             | Consume recovered energy of the motor and shorten deceleration time  |

#### 1. Leakage switch

The inside of VFD, inside of motor and input and output leads have earth electrostatic capacitance and the VFD has relatively high carrier frequency, so large earth leakage current is induced to the VFD, which is more obvious for high-capacity machines; the application of leakage switch may cause misoperation of protection circuit, so the attention should be paid to the selection of leakage switch during the application, simultaneously carrier frequency shall be reduced and the lead shortened appropriately.

#### 2. AC reactor

AC reactor can be used for suppressing higher harmonic of VFD input current, improving input power factor of the VFD and preventing leakage-induced impact. It is suggested to use input AC reactor under following circumstances:

- 1) Unbalanced three-phase power;
- 2) The same power supply is connected with thyristor or switch-controlled power factor compensating device;

### 8.2 Configuration

#### 1. AC reactor configuration

| Model | Matched power (W) | Rated current (A) | Inductance (mH) |
|-------|-------------------|-------------------|-----------------|
|-------|-------------------|-------------------|-----------------|

## V70 Series High Performance Vector Control Mini VFD

|      |      |      |  |
|------|------|------|--|
| 110V | 0.75 | 2.0  |  |
|      | 1.5  | 2.8  |  |
|      | 2.2  | 4.4  |  |
| 220V | 1.5  | 7    |  |
|      | 2.2  | 11   |  |
|      | 3.7  | 17   |  |
| 380V | 1.5  | 4    |  |
|      | 2.2  | 5    |  |
|      | 3.7  | 8.5  |  |
|      | 7.5  | 17.5 |  |

Line reactor, through which alternating current flows, is also called commutation reactor and applied to network incoming line and it is used for suppressing VFD harmonic and feedbacking to the network.

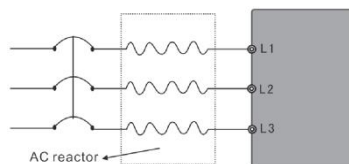

Figure 8-1 AC Reactor

### 2. Brake resistor configuration

| Model of VFD | Specification of brake resistor |          | Brake torque 10%ED | Dedicated motor KW |
|--------------|---------------------------------|----------|--------------------|--------------------|
|              | W                               | $\Omega$ |                    |                    |
| V70-0.75S1   |                                 |          | 125                | 0.75               |
| V70-1.5S1    |                                 |          | 125                | 1.5                |
| V70-2.2S1    |                                 |          | 125                | 2.2                |
| V70-1.5S2    | 300                             | 100      | 125                | 1.5                |
| V70-2.2S2    | 300                             | 70       | 125                | 2.2                |
| V70-3.7S2    | 390                             | 40       | 125                | 3.7                |

V70 Series High Performance Vector Control Mini VFD

|           |      |     |     |     |
|-----------|------|-----|-----|-----|
| V70-1.5T4 | 300  | 400 | 125 | 1.5 |
| V70-2.2T4 | 300  | 250 | 125 | 2.2 |
| V70-3.7T4 | 400  | 150 | 125 | 3.7 |
| V70-7.5T4 | 1000 | 75  | 125 | 7.5 |

- [Note] 1) Please select resistance value and service power set by our company;
- 2) Our company shall assume no responsibility for the damage of VFD or other devices induced by the application of brake resistor and brake unit which are not provided by our company;
- 3) Be sure to take the safety and inflammability of the environment for installation of brake resistor and make the distance between it and VFD up to 100mm at least;
- 4) For changing resistance and power number, please contact local dealer;
- 5) In need of brake resistor, separately order brake resistor, and contact local dealer for details;
- 6) It is necessary to install brake unit if quick braking is required of the VFD over 11KW.

## Annex

## Annex I Examples of Simple Application

## 1. Forward/reverse rotation of motor in the control of potentiometer

As shown in the curve of Figure F-3.

Parameter setting    F001=1            F002=1            F072=50            F073=50  
                               F074=0            F075=1            F076=1

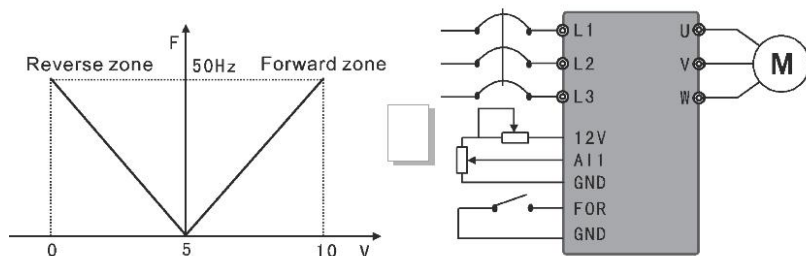

Figure F-3 Motor Forward/Reverse Curve and Wiring Diagram

## 2. Internally controlled 8-segment speed operation

Realize those shown in the curve of Figure F-4 and stop internally controlled 8-segment speed after operating by one cycle.

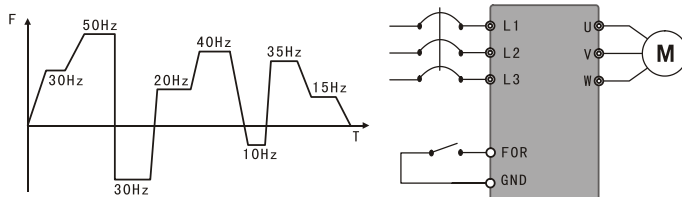

Figure F-4 Operation Curve and Wiring Diagram of Internally Controlled 8-segment Speed

Parameter setting    F080=1            F003=30            F086=50            F087=30            F088=20  
                               F089=40            F090=10            F091=35            F092=15            F082=36  
                               F081=0            F014=5            F015=5            F001=1            F083=0

F044=1 F101-F108=15

- [Description] 1) Operating time of each segment speed is set via F101-F108=15;  
 2) Automatic cycle F081=1;  
 3) After giving operating instruction, stop after operating by one cycle as per set curve.

### 3. Simple constant-pressure water supply

(1) Use pressure transmitter with the range of 0-10kg and feedback of 4-20mA; pressure water supply of 5kg as required, alarm while above upper limit of 6kg and below lower limit of 4kg, and stop starting external terminal. As shown in Figure F-5.

Parameter setting F001=1 F002=0 F046 (X3 terminal function) =25 F052=28  
 F053=29 F070=10 F156=\* F157=\* F158=\*  
 F159=50 F160=0 F161=60 F162=40

[Note] F156, F157 and F158 shall be set based on actual situations, and in general, constant-pressure water supply F156=80-100, F157=2.5- ~ 3 and F158=0.

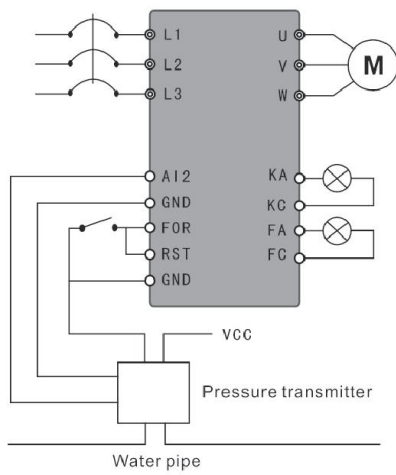

Figure F-5 Constant-Pressure Water Supply – Pressure Transmitter

(2) Use remote pressure gauge of 0-10kg; as required, use external terminal to control the operation and stop and set target value via potentiometer. As shown in Figure F-6.

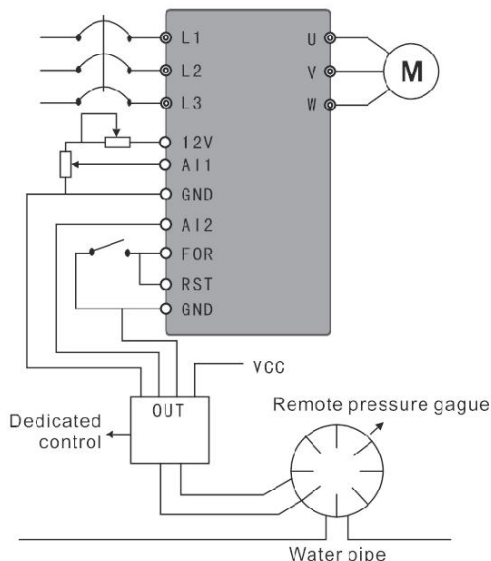

Figure F-6 Constant-pressure Water Supply – Remote Pressure Gauge

|                   |        |        |         |        |
|-------------------|--------|--------|---------|--------|
| Parameter setting | F001=1 | F002=0 | F046=25 | F070=3 |
|                   | F156=* | F157=* | F158=*  | F160=1 |

## [Note]

- 1) Target value of V70 series VFD can be selected through two methods, one referring setting via panel and the other one referring to 0-10V analog ;
- 2) Feedback signal is 4-20mA and the others are invalid;
- 3) Target value in the case is set via potentiometer (0-10V);
- 4) F156, F157 and F158 shall be set based on concrete conditions (refer to parameter description for details);
- 5) PID special control board is designed as common remote pressure gauge and input internal resistance is converted into standard signal as per 0-400Ω; in case that the resistance of remote pressure gauge used by the user exceeds prescribed limit, remote pressure gauge shall be replaced or the previous resistor shall be connected in parallel for calibration;
- 6) When target value is set via potentiometer, F002 still must be set to 0; otherwise, PID shall be ineffective.

## Annex II External and Installation Dimensions

### 1. External dimension of F0 shell

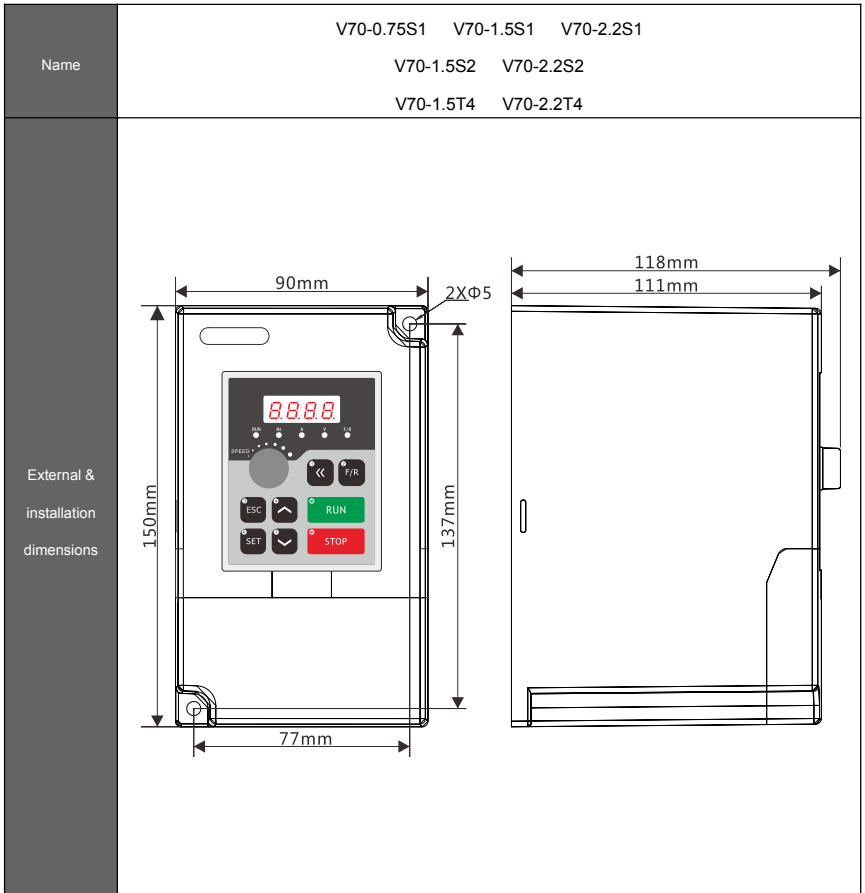



## 2. External dimension of F1 shell

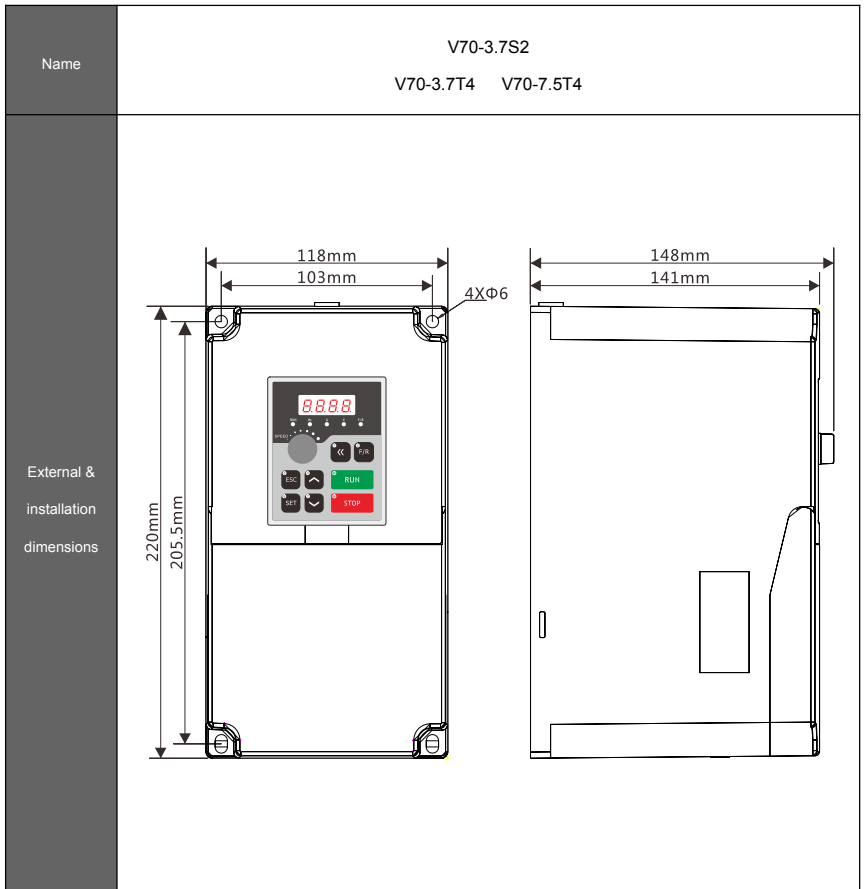

## 3. Installation dimension of keyboard

The keyboard can be removed from the VFD and installed on the cabinet connect by extension cable.

### ◆ Direct Installation Method

- ① Open holes on the cabinet as shown below;
- ② Remove the keyboard from the VFD to cabinet

- ③ one end of the extension cable into the keyboard , and the other end into the socket of the VFD keyboard.